

Scene	Duration	Panel	Duration
1	07:00	9	00:12



Scene	Duration	Panel	Duration
1	07:00	10	00:12



Scene	Duration	Panel	Duration
1	07:00	11	02:00

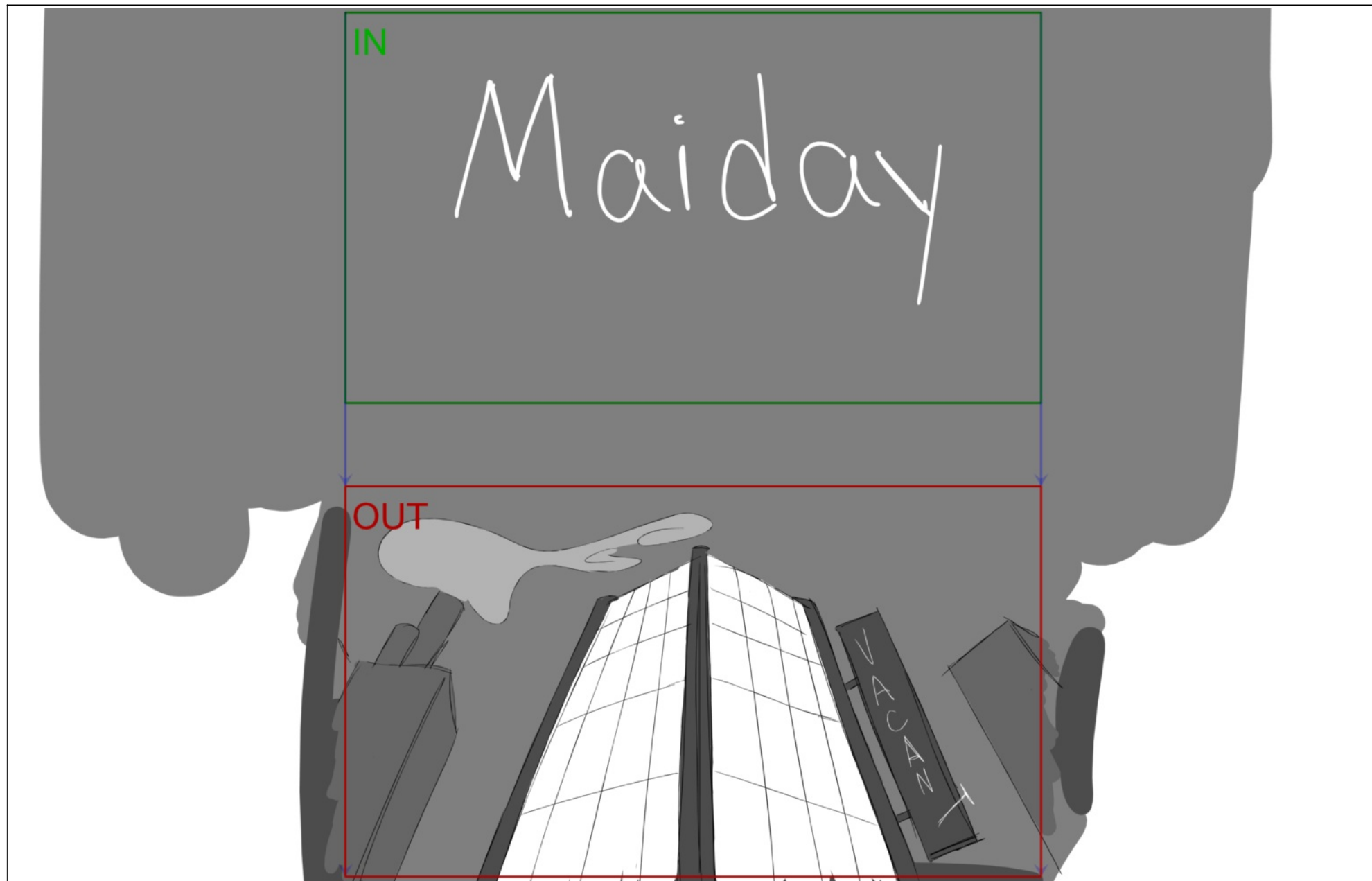

Scene	1_A_0	Duration	02:00	Panel	1	Duration	01:00
-------	-------	----------	-------	-------	---	----------	-------

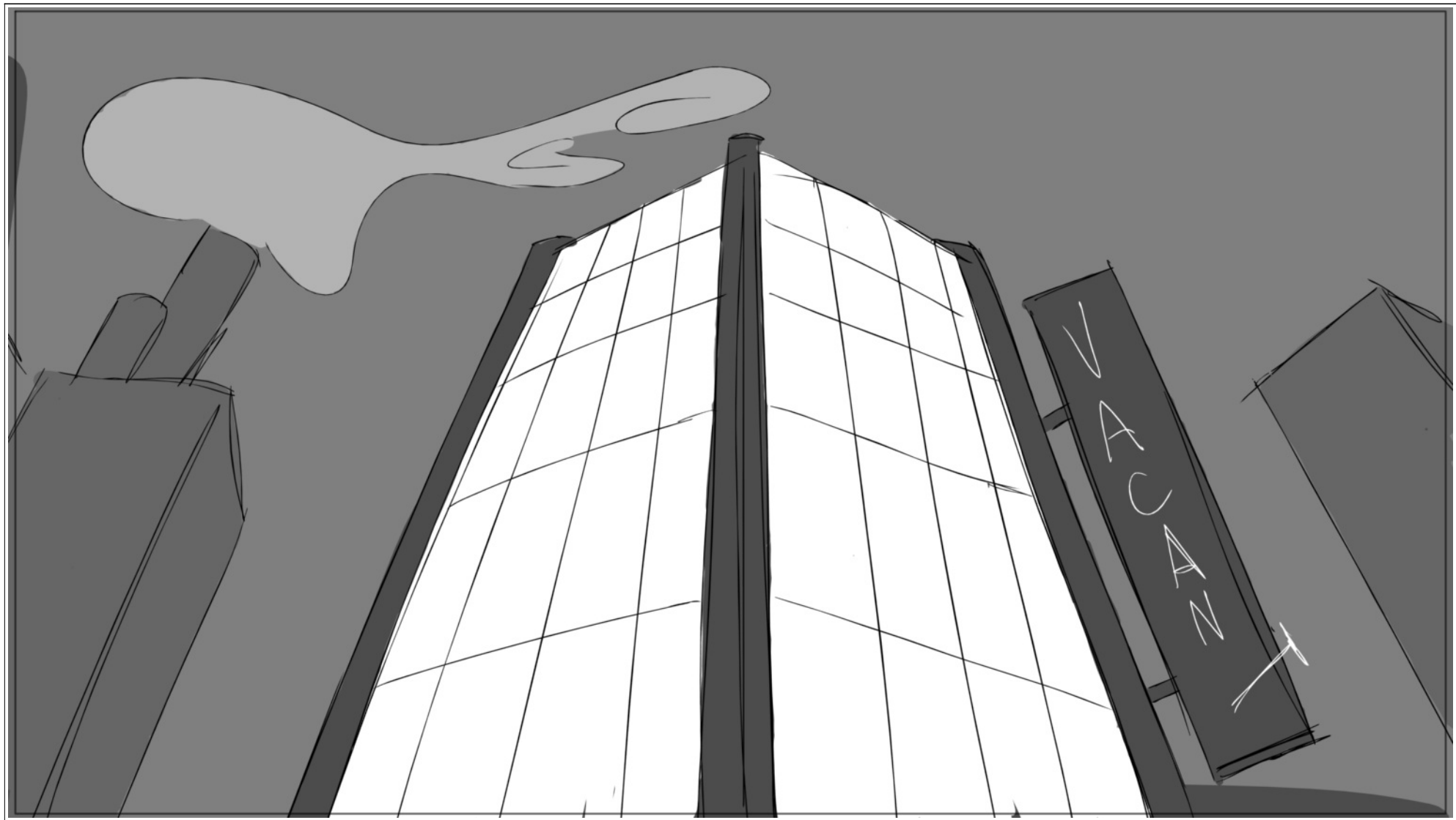

Scene	1_A_0	Duration	02:00	Panel	2	Duration	01:00
-------	-------	----------	-------	-------	---	----------	-------

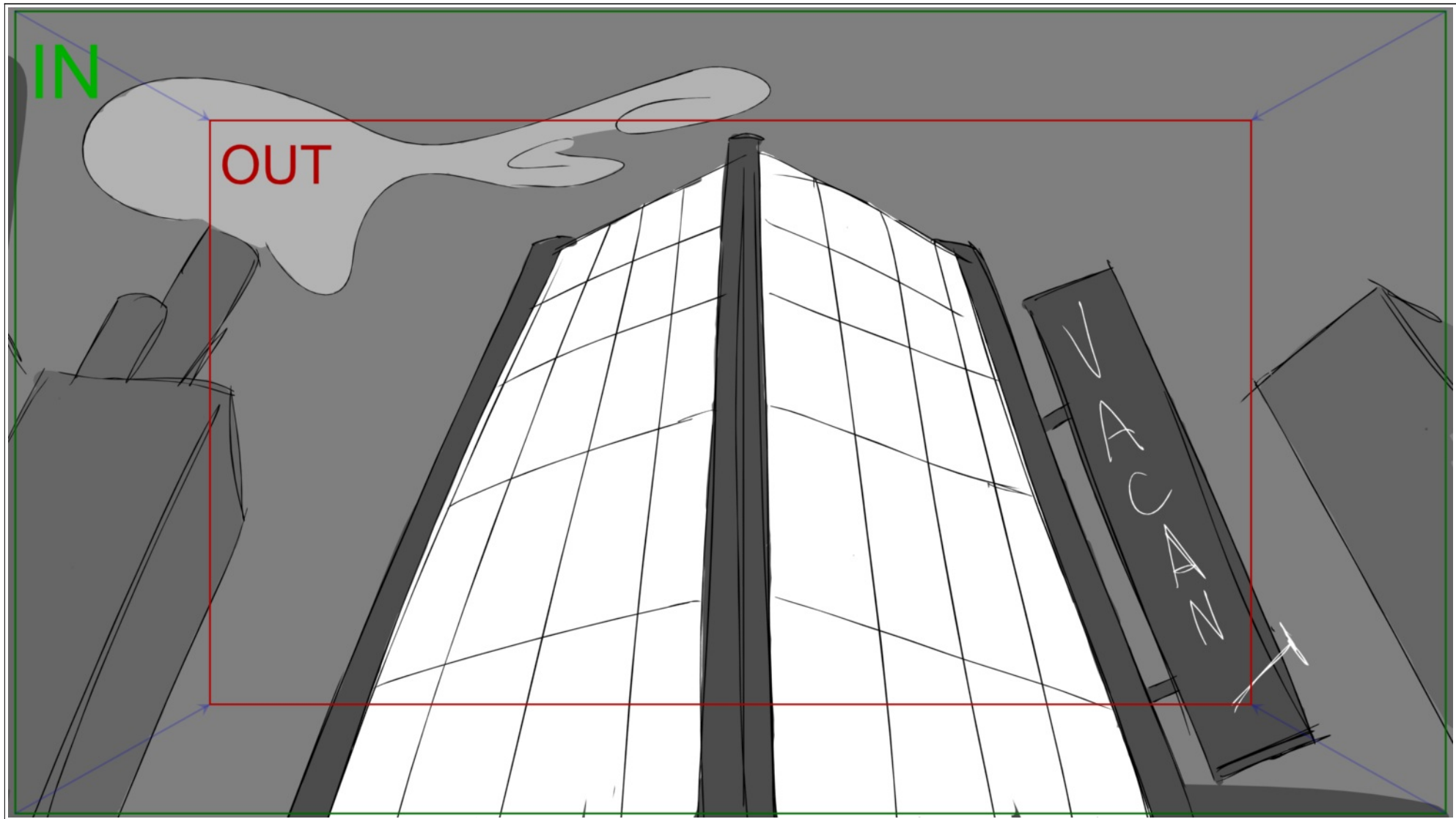

Scene	Duration	Panel	Duration
1_A	07:16	1	02:00

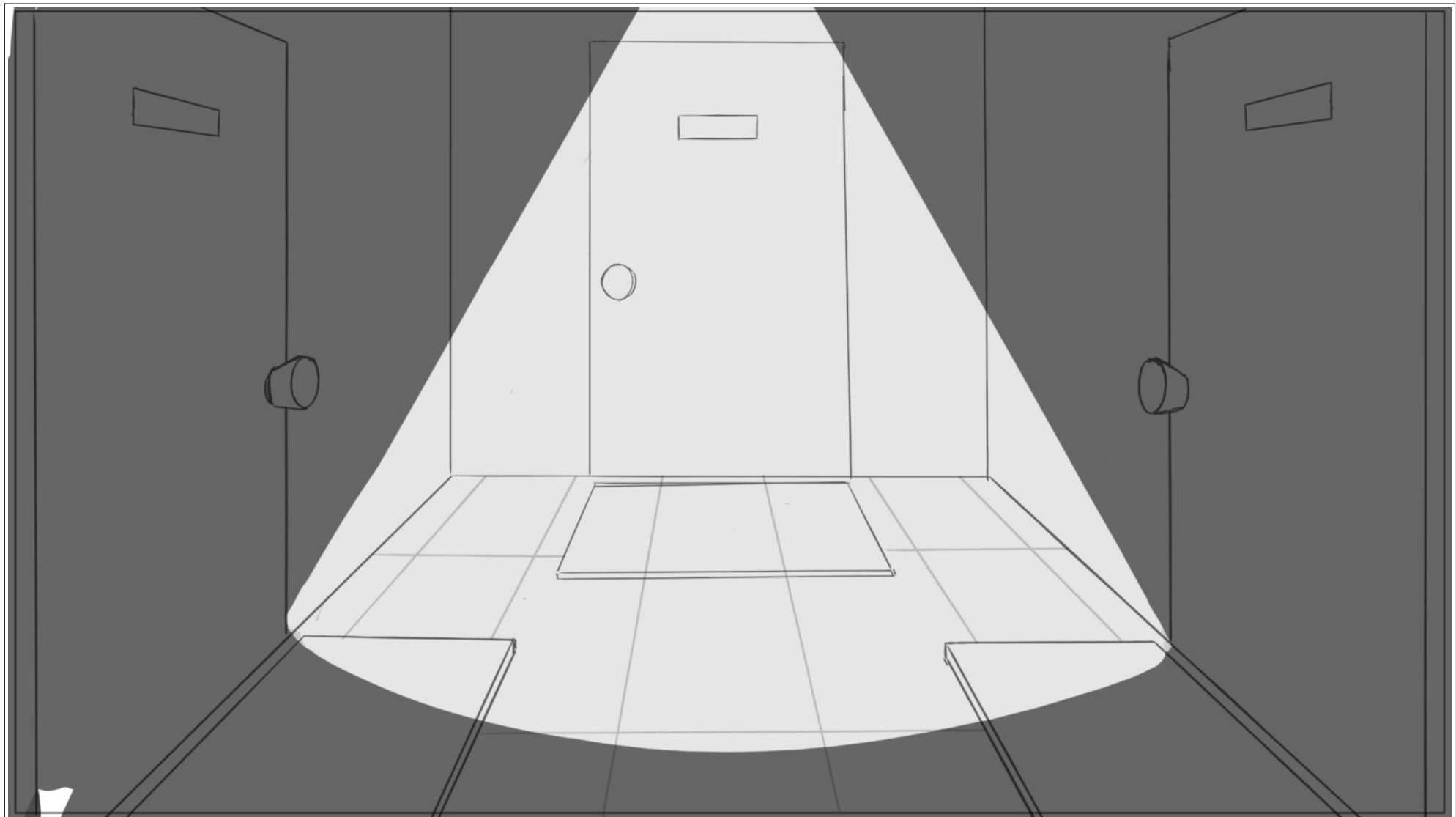

Scene	Duration	Panel	Duration
1_A	07:16	2	01:00

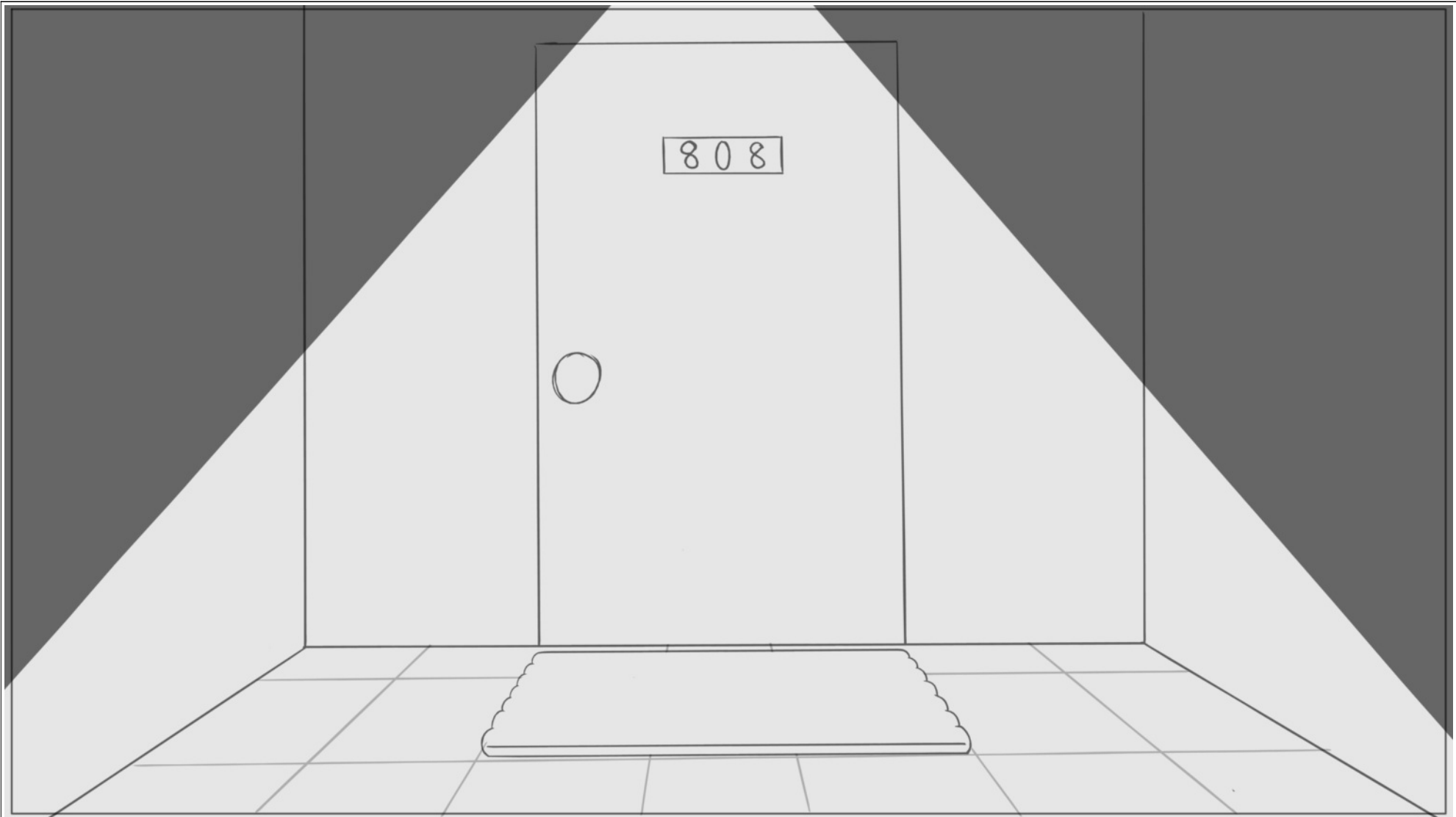

Scene	Duration	Panel	Duration
1_A	07:16	3	01:12

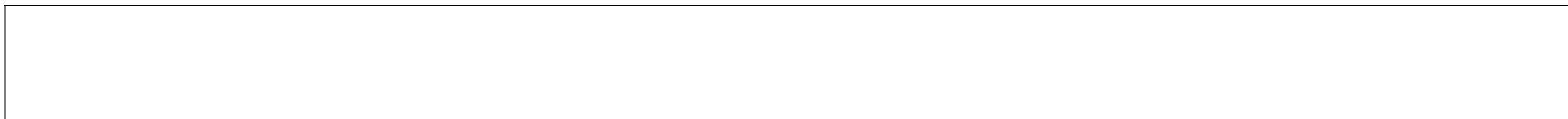
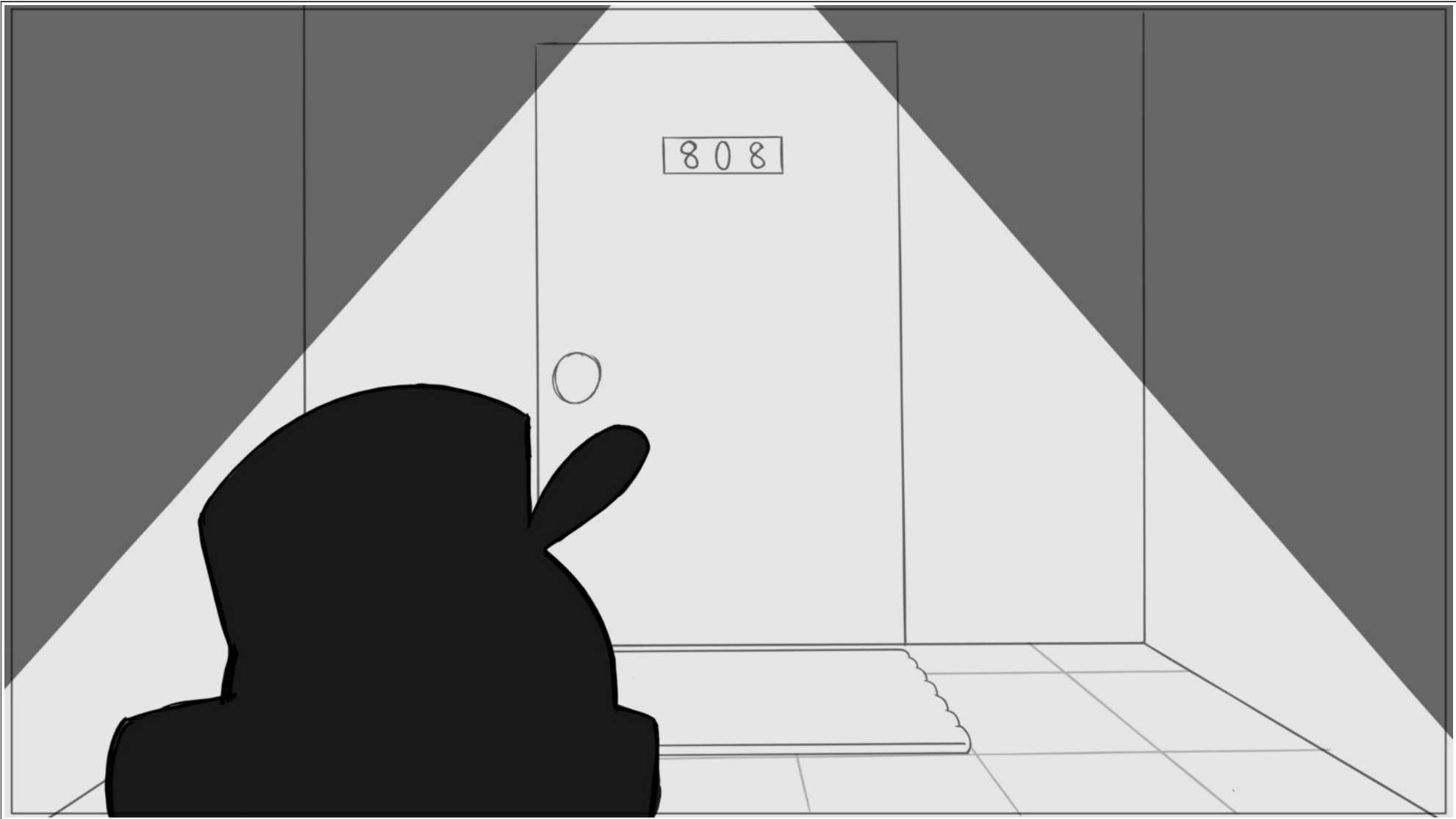

Scene	Duration	Panel	Duration
1_A	07:16	4	01:00

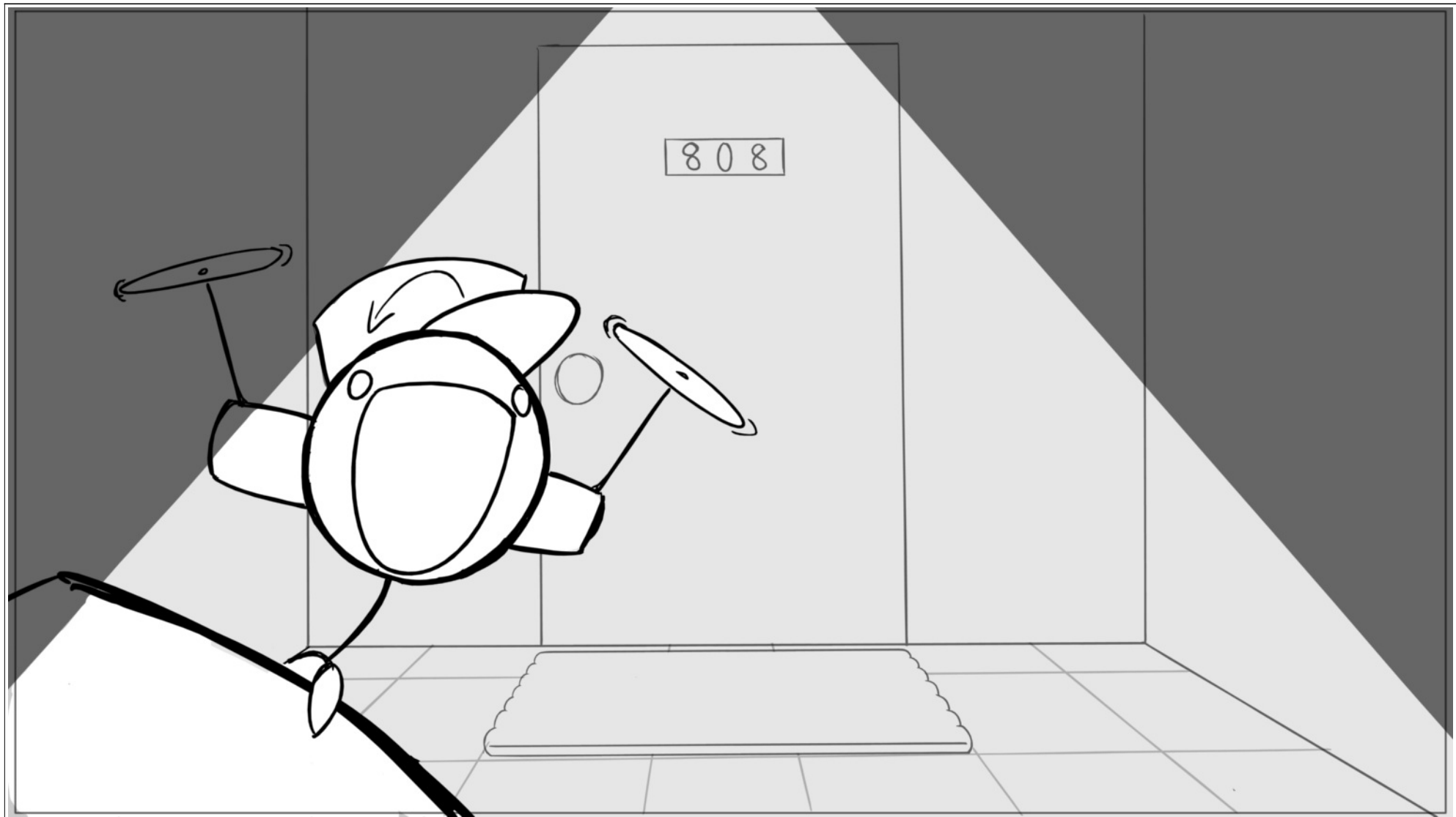

Scene	Duration	Panel	Duration
1_A	07:16	5	01:00

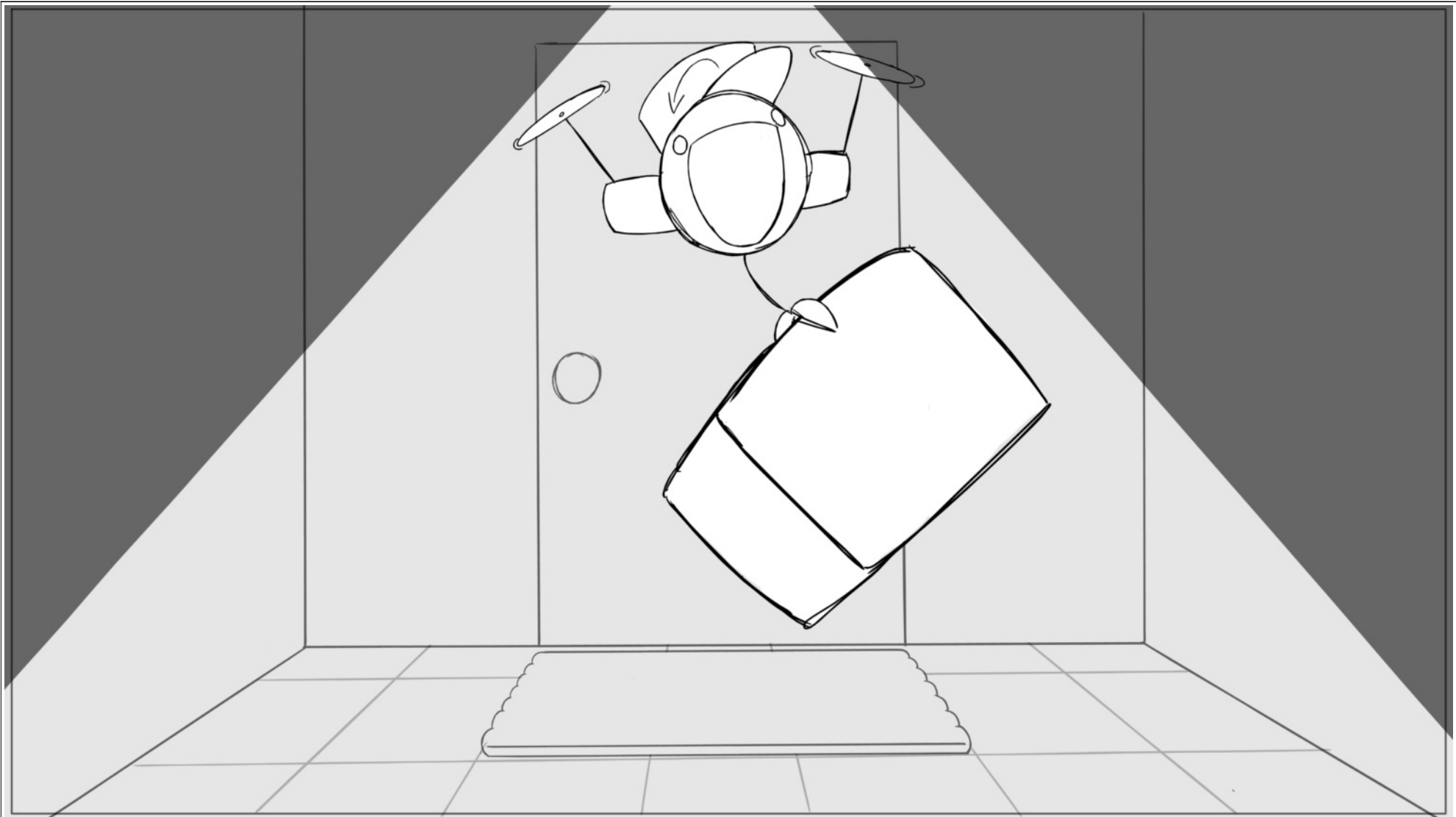

Scene	Duration	Panel	Duration
1_A	07:16	6	01:00

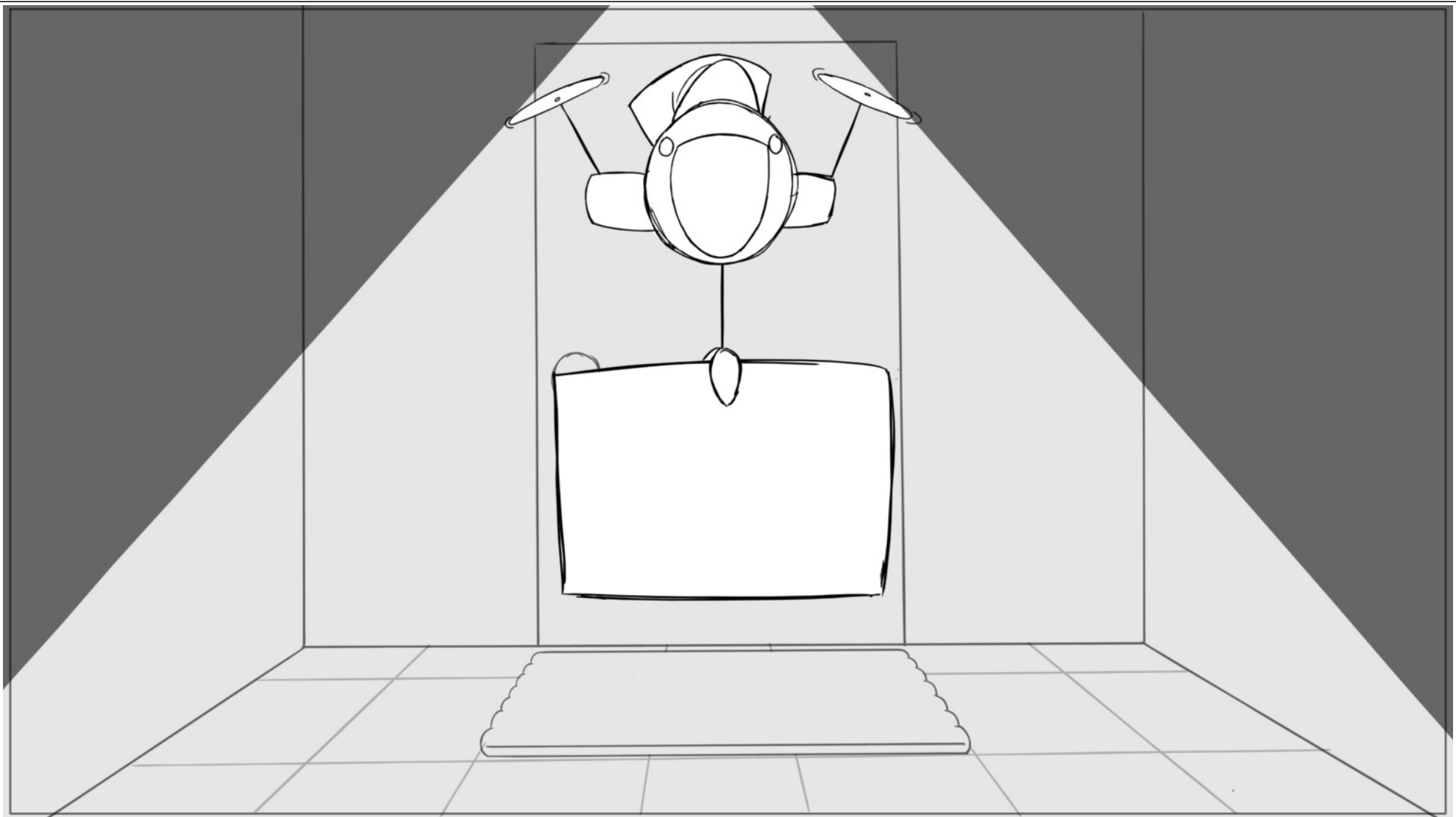

Scene	Duration	Panel	Duration
1_A	07:16	7	00:02

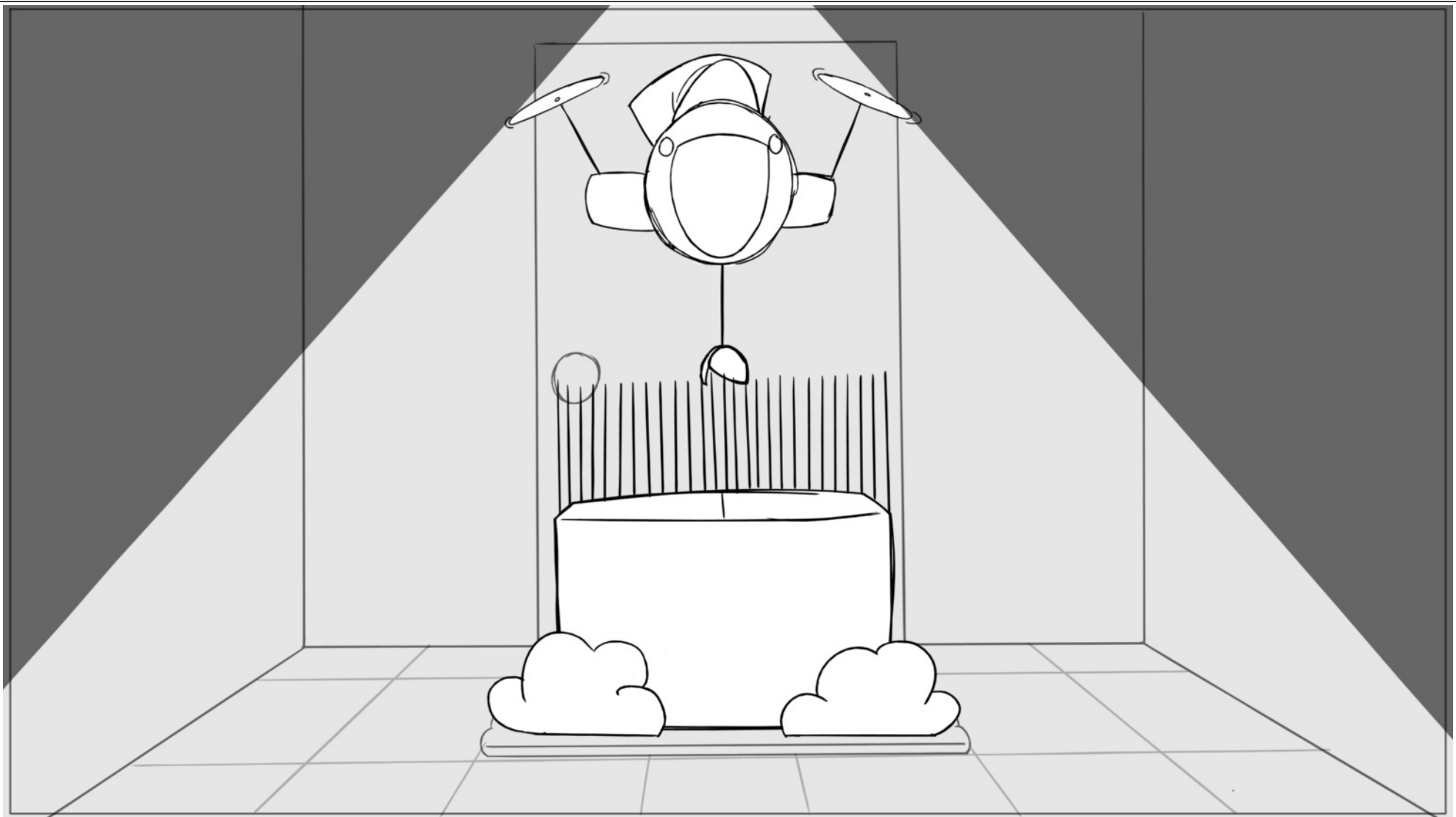

Scene	1_A	Duration	07:16	Panel	8	Duration	00:02
-------	-----	----------	-------	-------	---	----------	-------

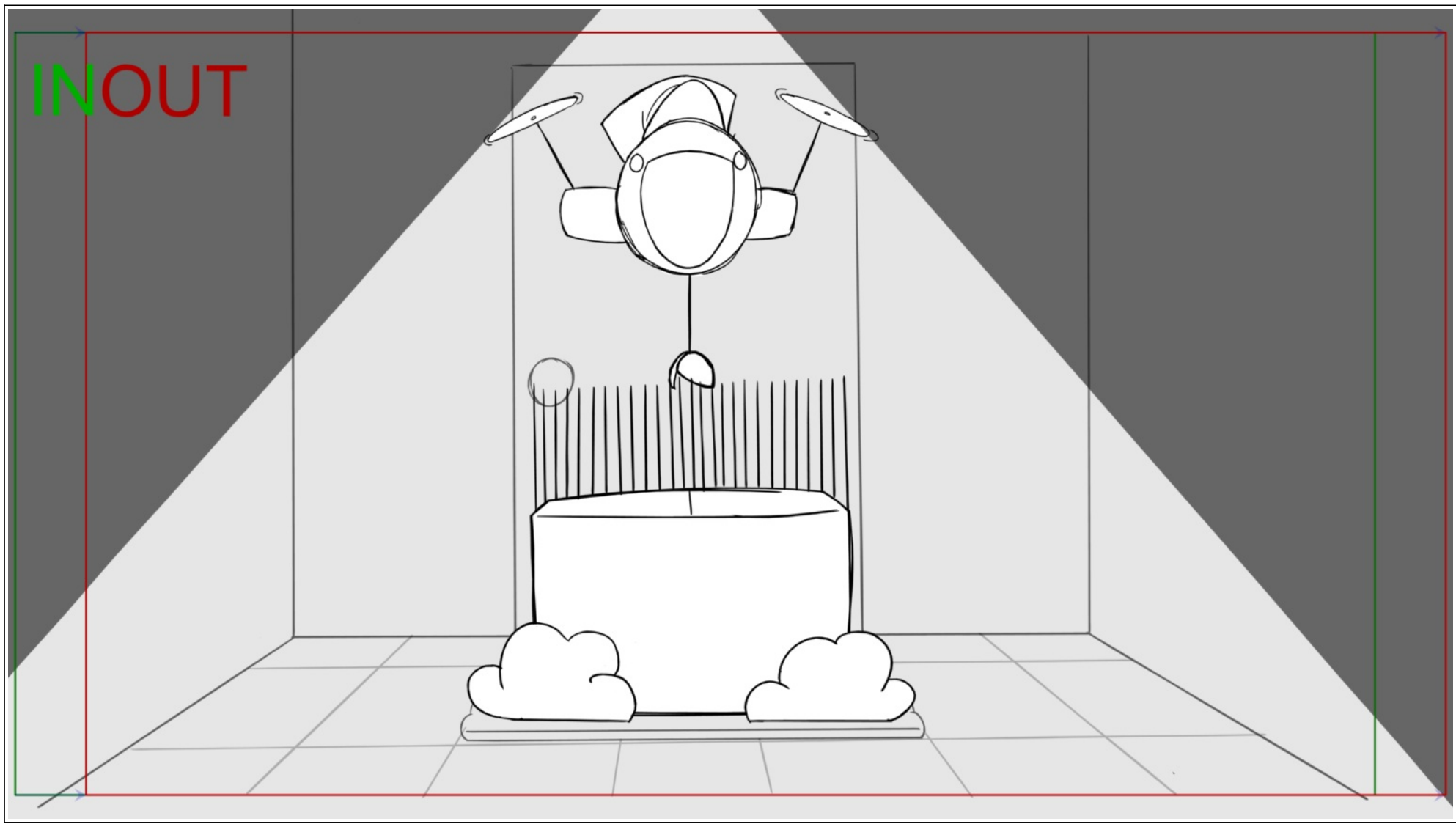

Scene	1_A_1_999	Duration	00:04	Panel	1	Duration	00:02
-------	-----------	----------	-------	-------	---	----------	-------

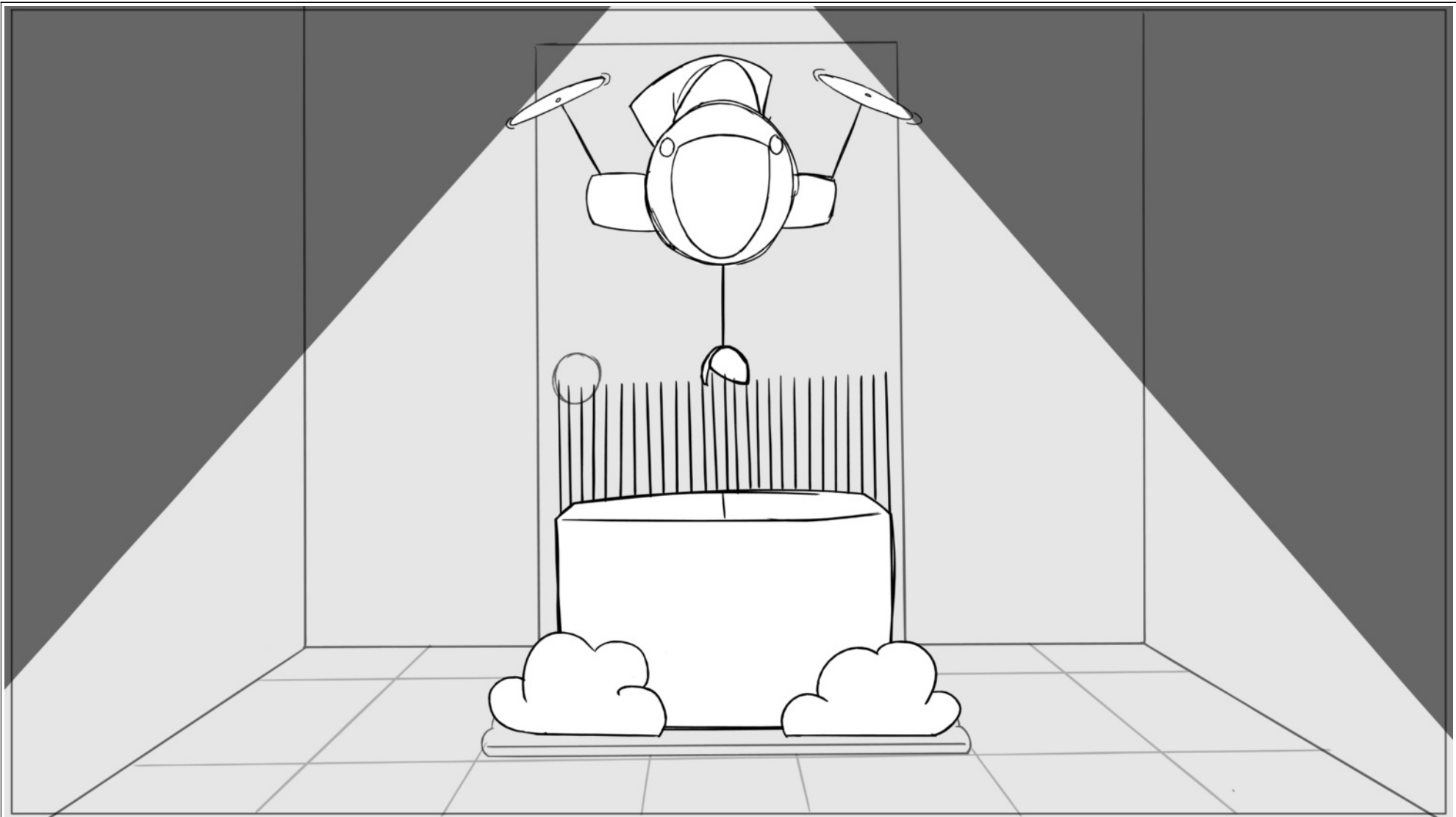

Scene	1_A_1_999	Duration	00:04	Panel	2	Duration	00:02
-------	-----------	----------	-------	-------	---	----------	-------

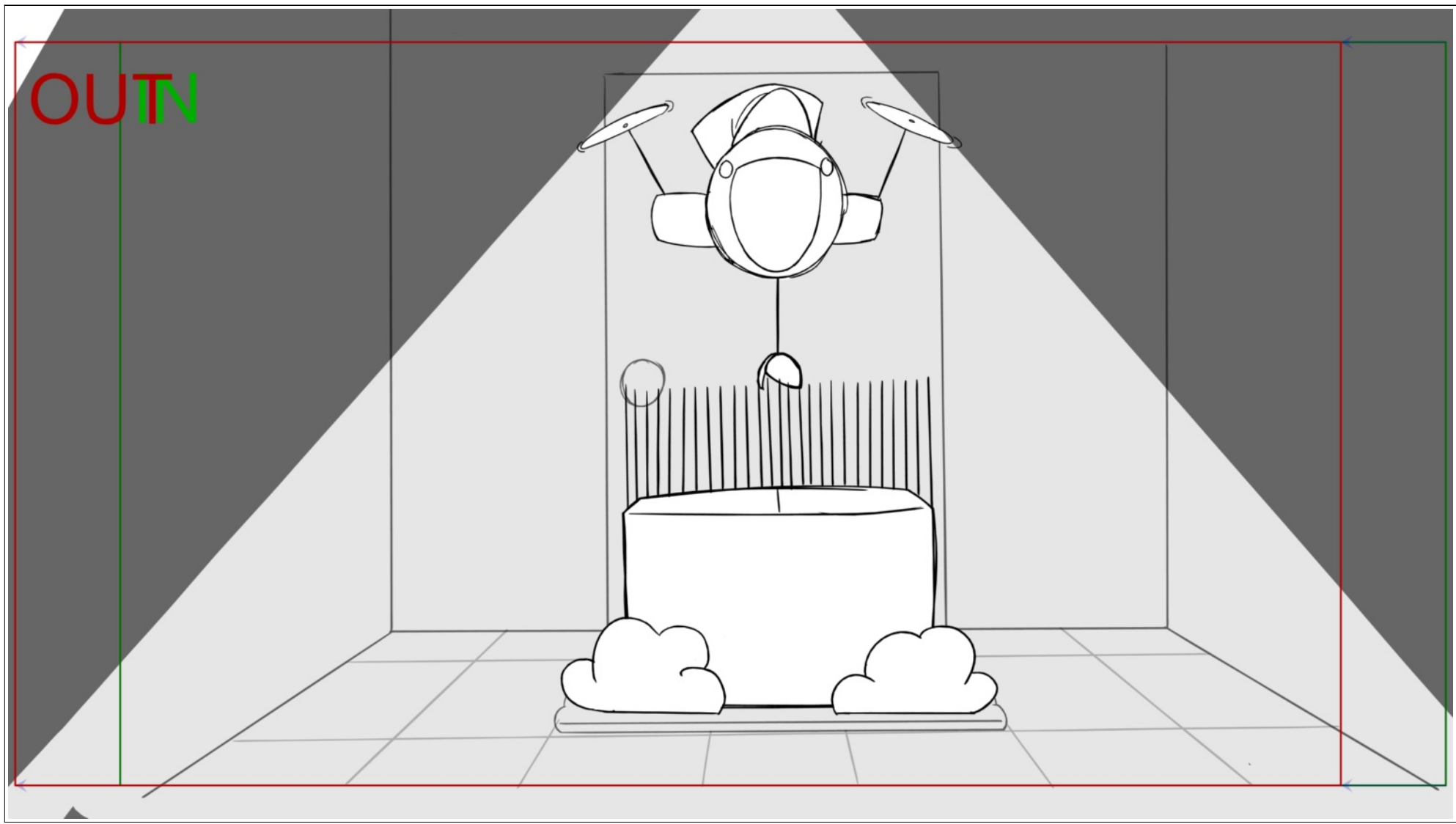

Scene	1_A_1_0	Duration	01:00	Panel	1	Duration	01:00
-------	---------	----------	-------	-------	---	----------	-------

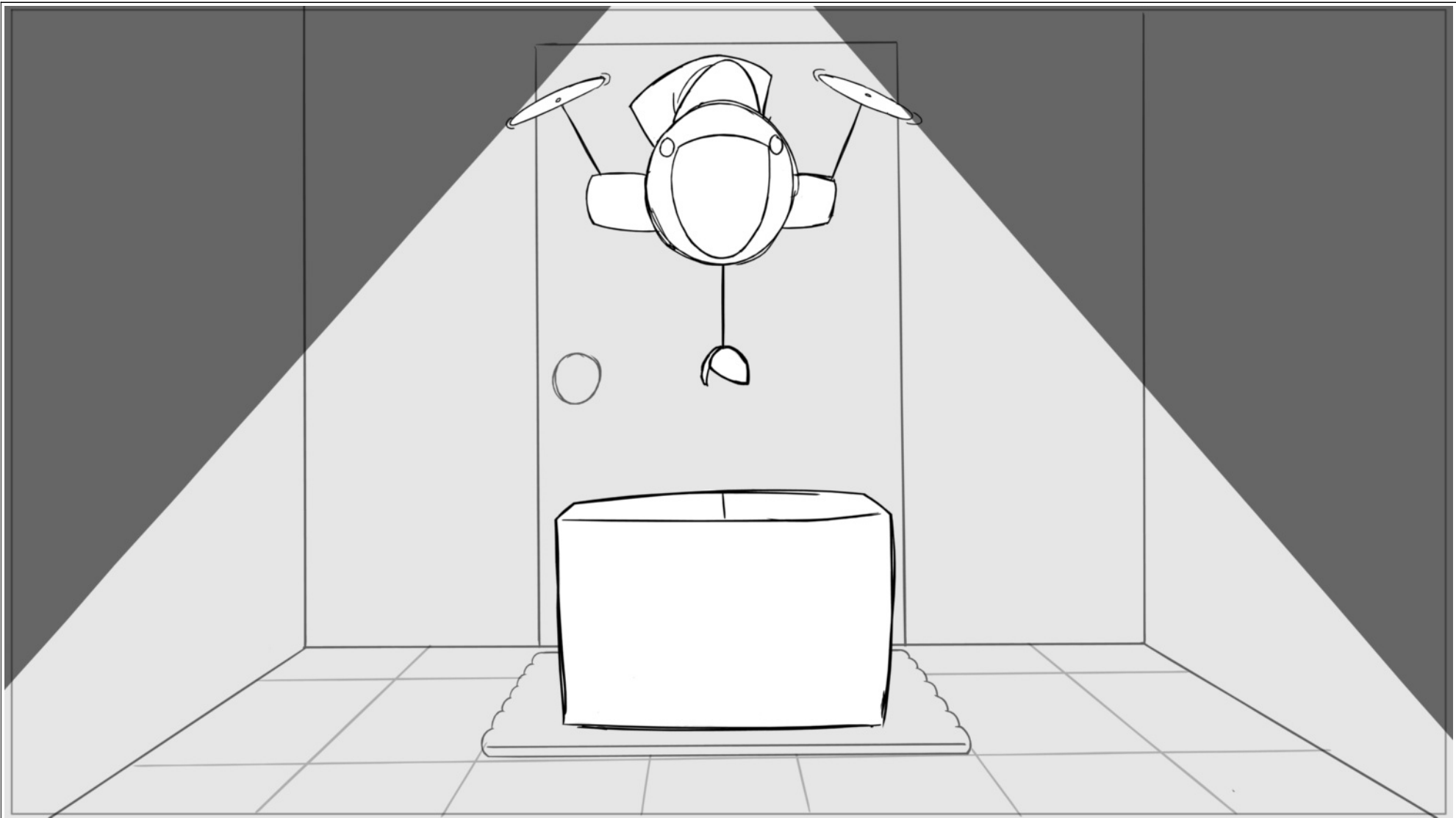

Scene	1_A_1	Duration	07:00	Panel	1	Duration	01:00
-------	-------	----------	-------	-------	---	----------	-------

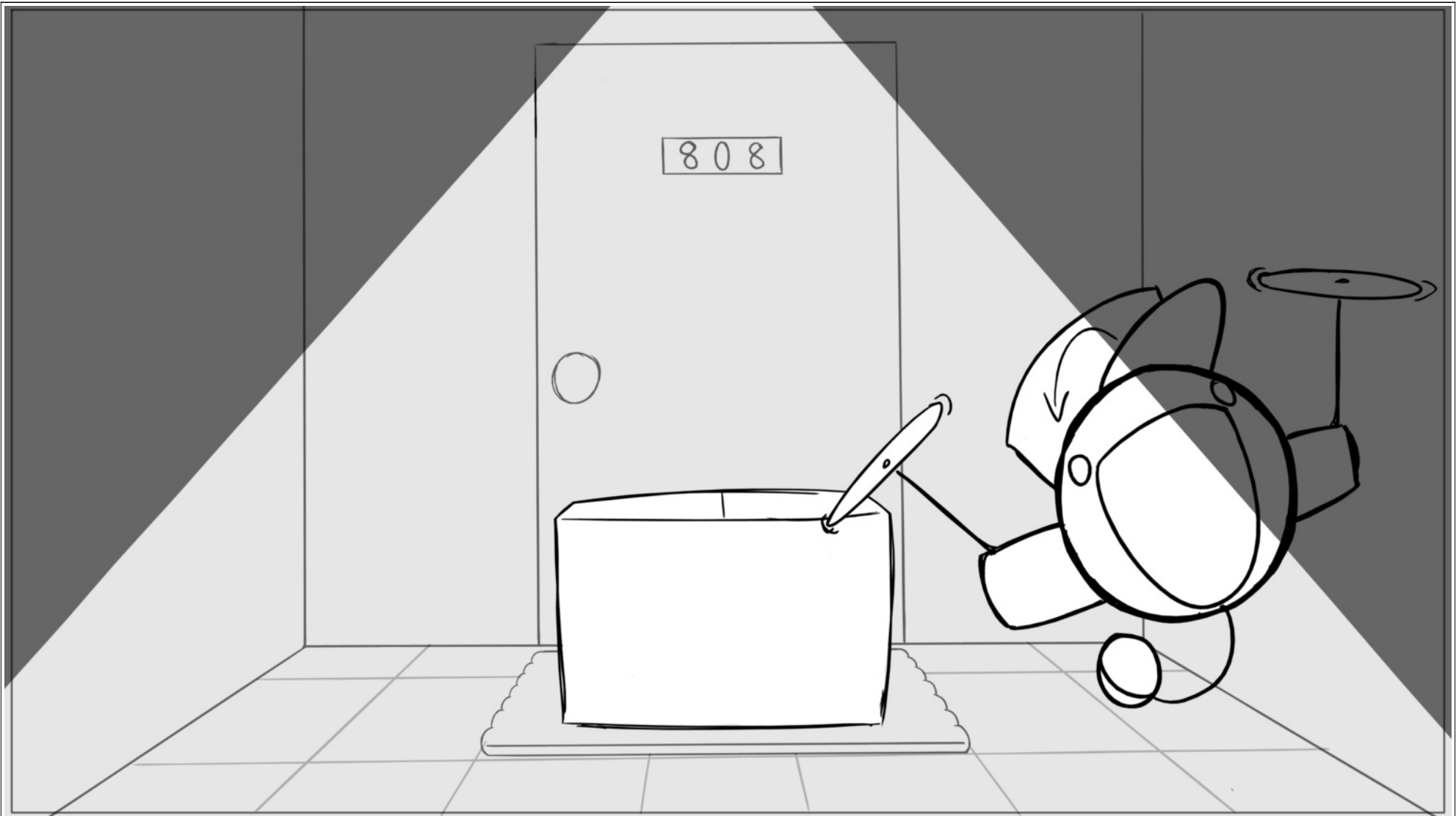

Scene	1_A_1	Duration	07:00	Panel	2	Duration	01:00
-------	-------	----------	-------	-------	---	----------	-------

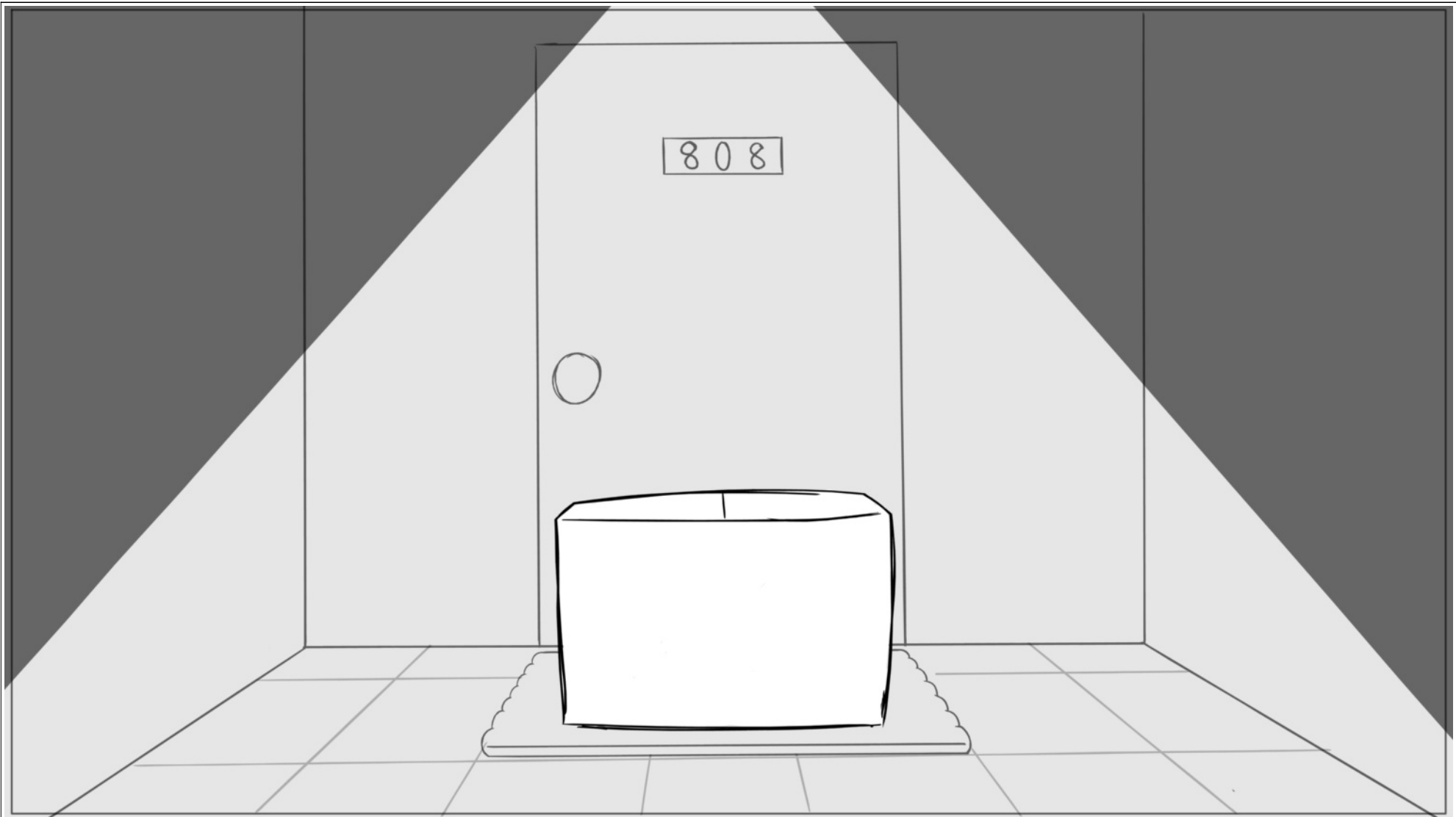

Scene	1_A_1	Duration	07:00	Panel	3	Duration	00:12
-------	-------	----------	-------	-------	---	----------	-------

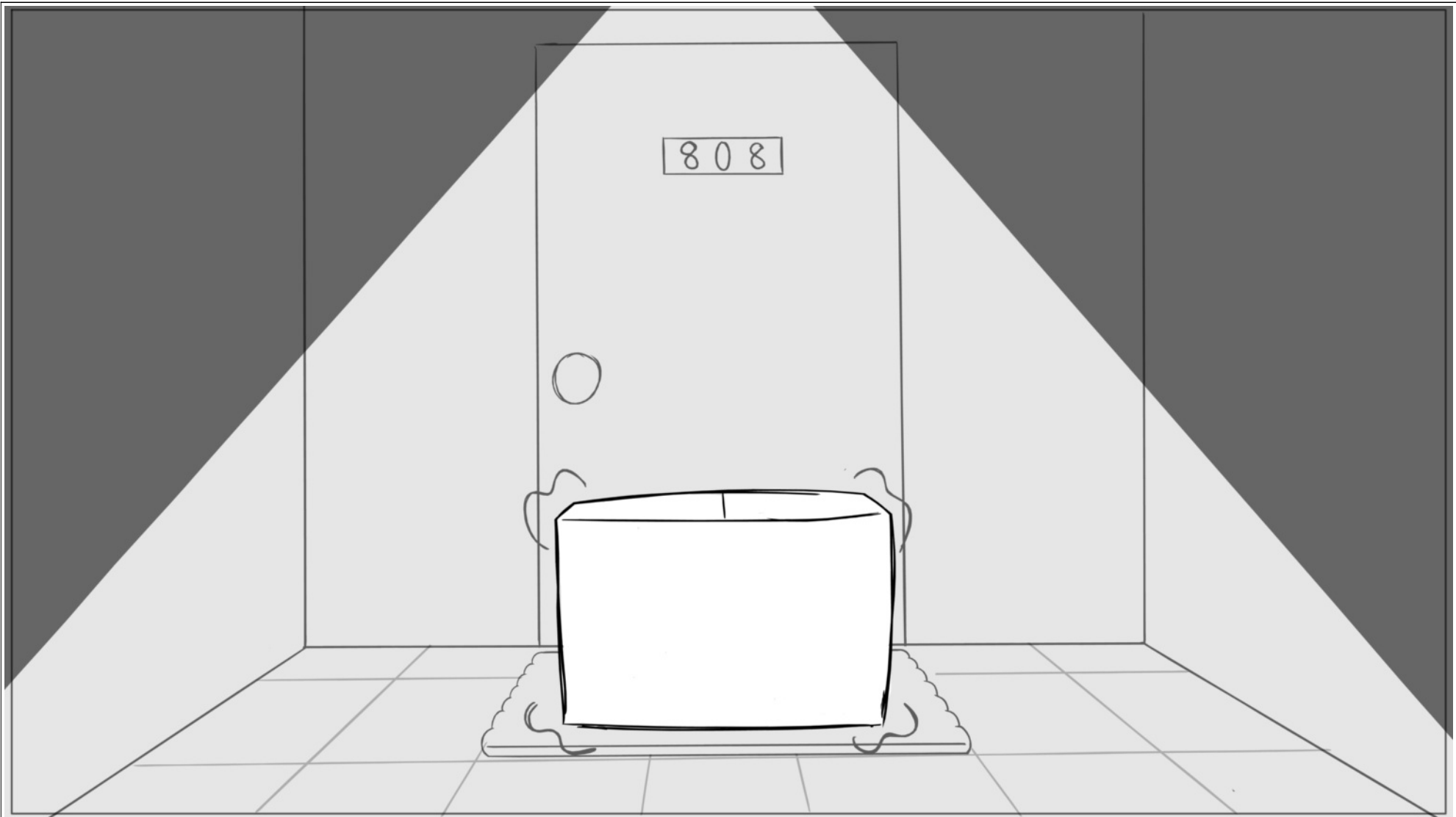

Scene	1_A_1	Duration	07:00	Panel	4	Duration	04:12
-------	-------	----------	-------	-------	---	----------	-------

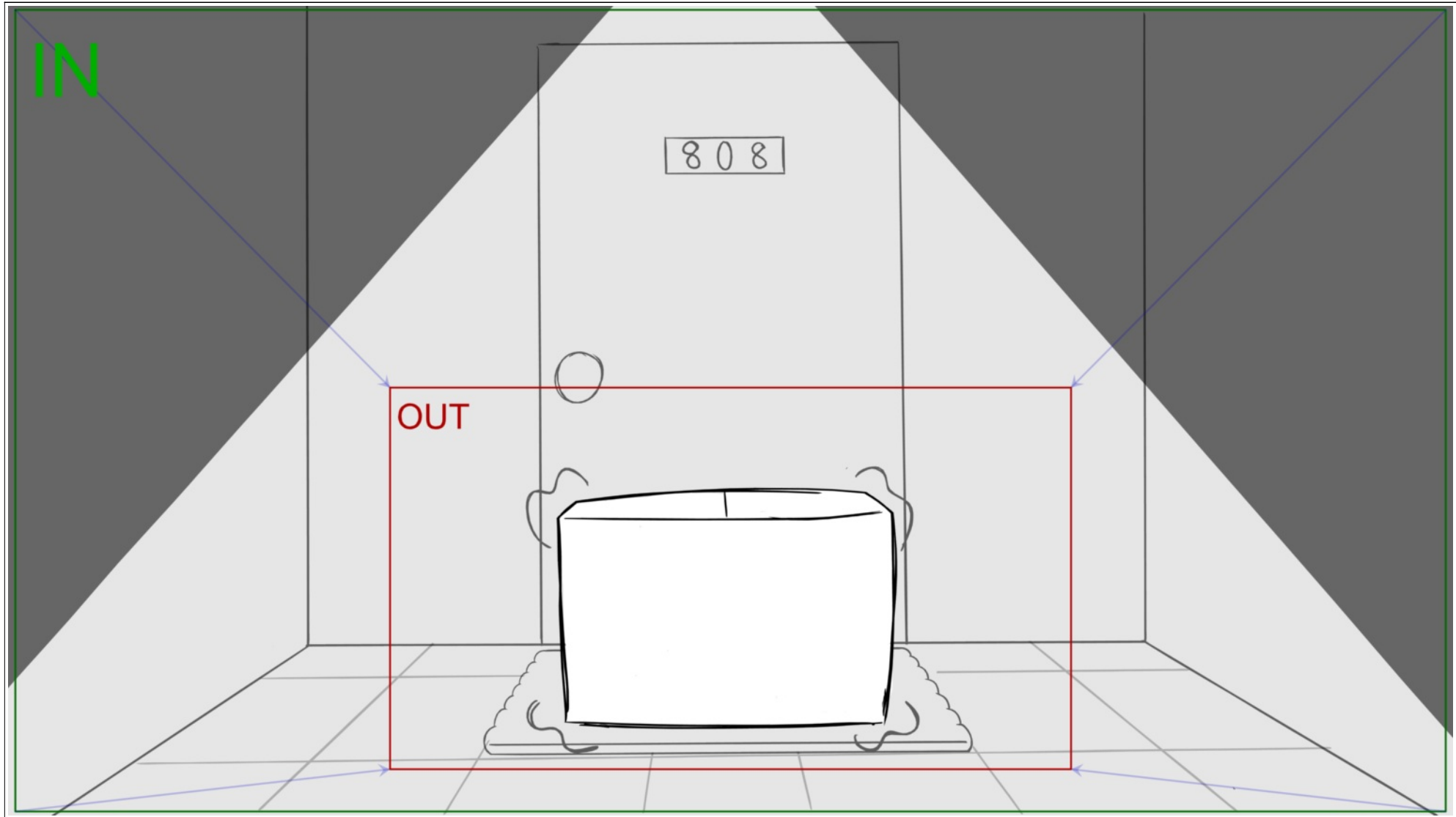

Scene	Duration	Panel	Duration
1_A_1_A_0	01:12	1	01:12



Scene	Duration	Panel	Duration
1_A_1_A	02:22:18	1	02:00

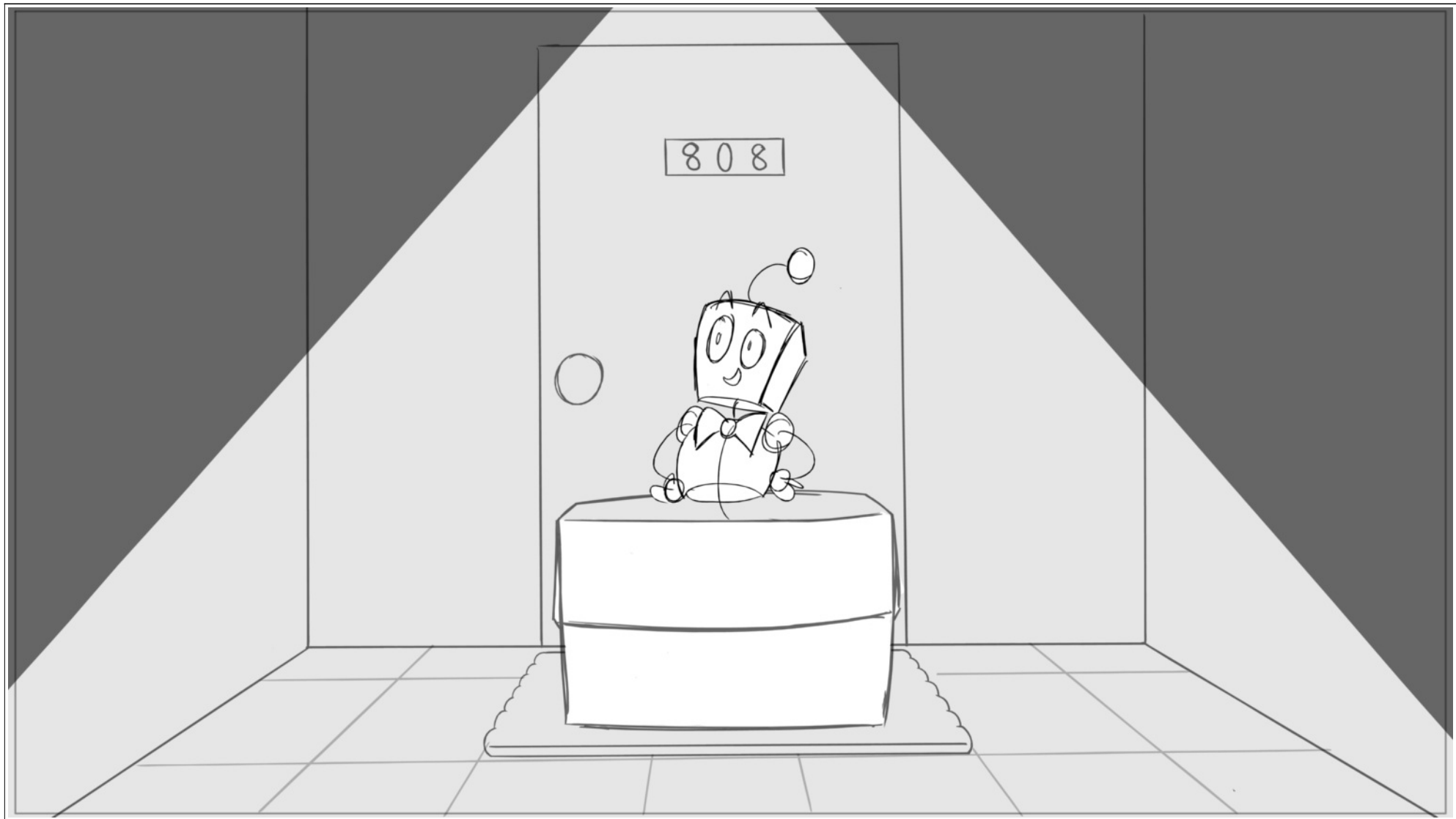

Scene	Duration	Panel	Duration
1_A_1_A	02:22:18	2	01:00



Scene	Duration	Panel	Duration
1_A_1_A	02:22:18	3	01:00

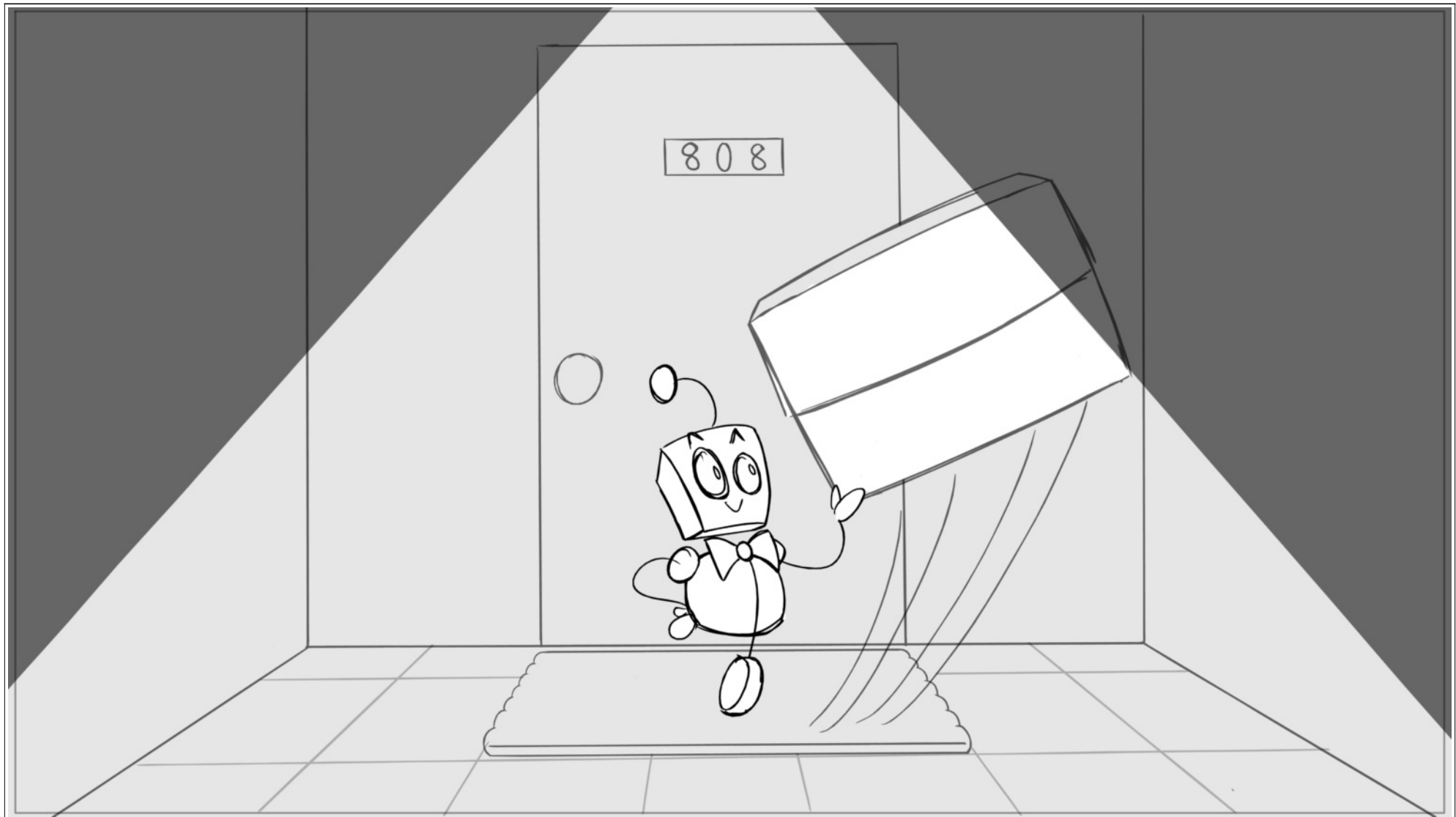

Scene	Duration	Panel	Duration
1_A_1_A	02:22:18	4	01:00

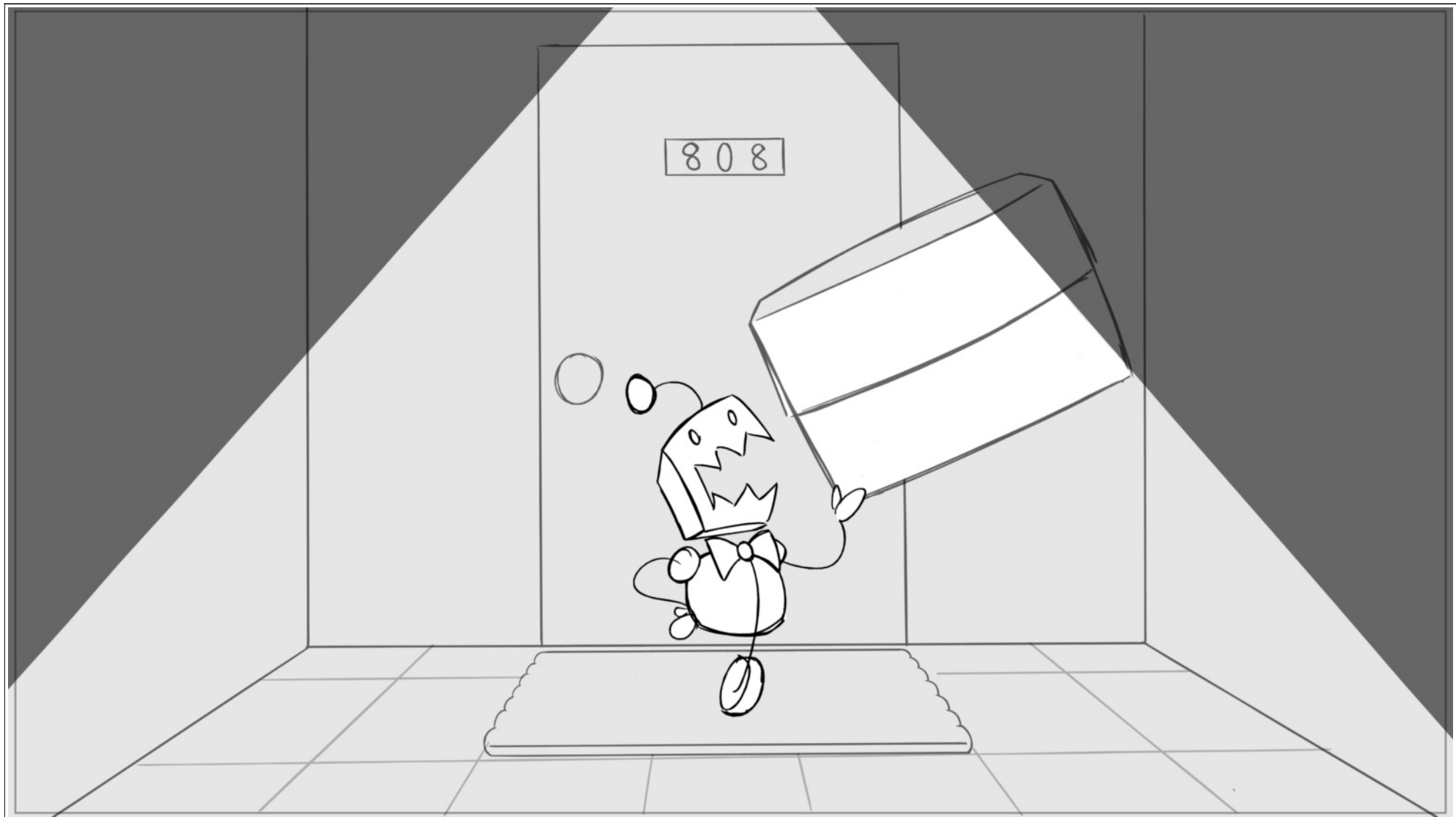

Scene	Duration	Panel	Duration
1_A_1_A	02:22:18	5	01:00

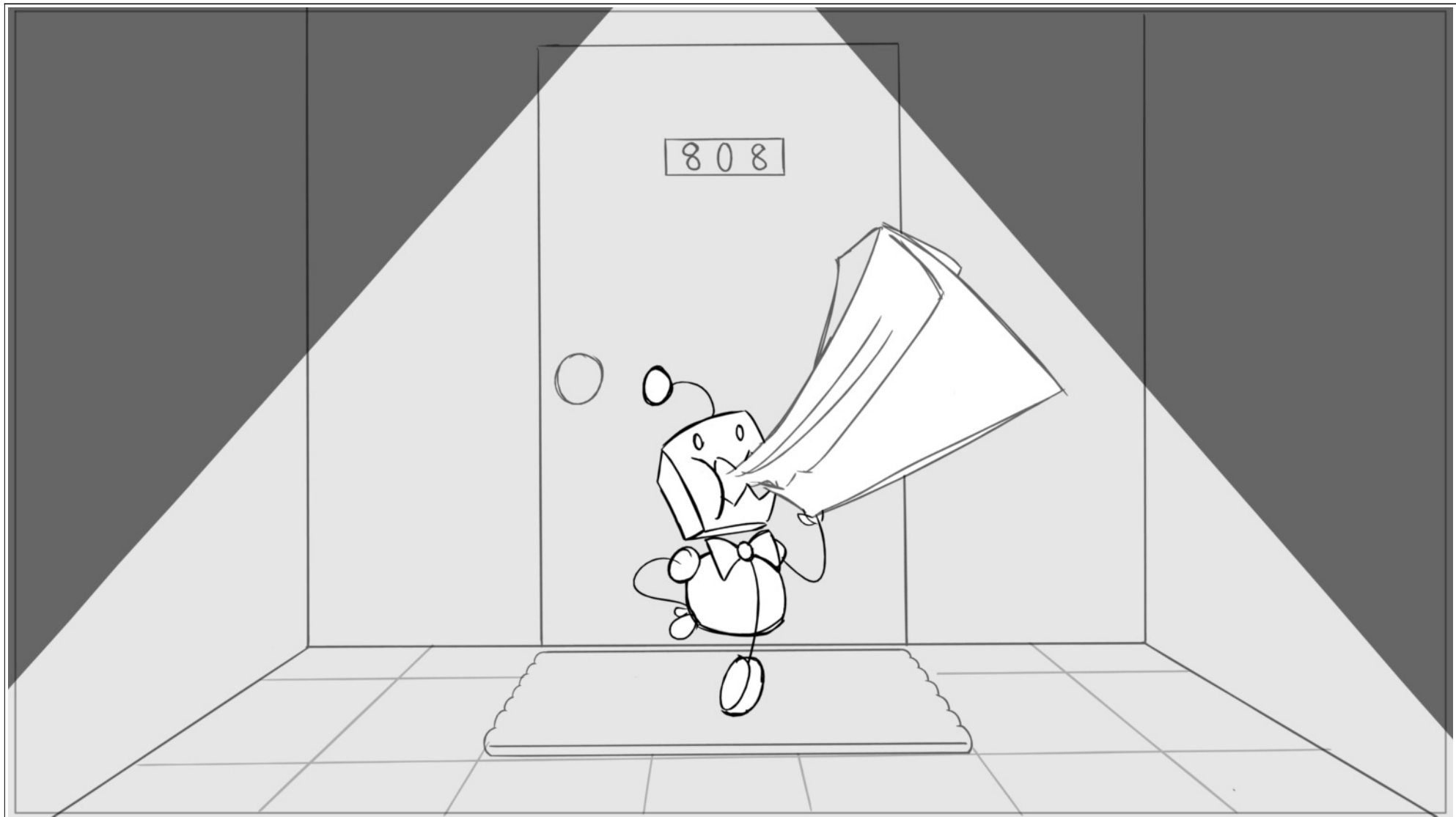

Scene	Duration	Panel	Duration
1_A_1_A	02:22:18	6	02:00

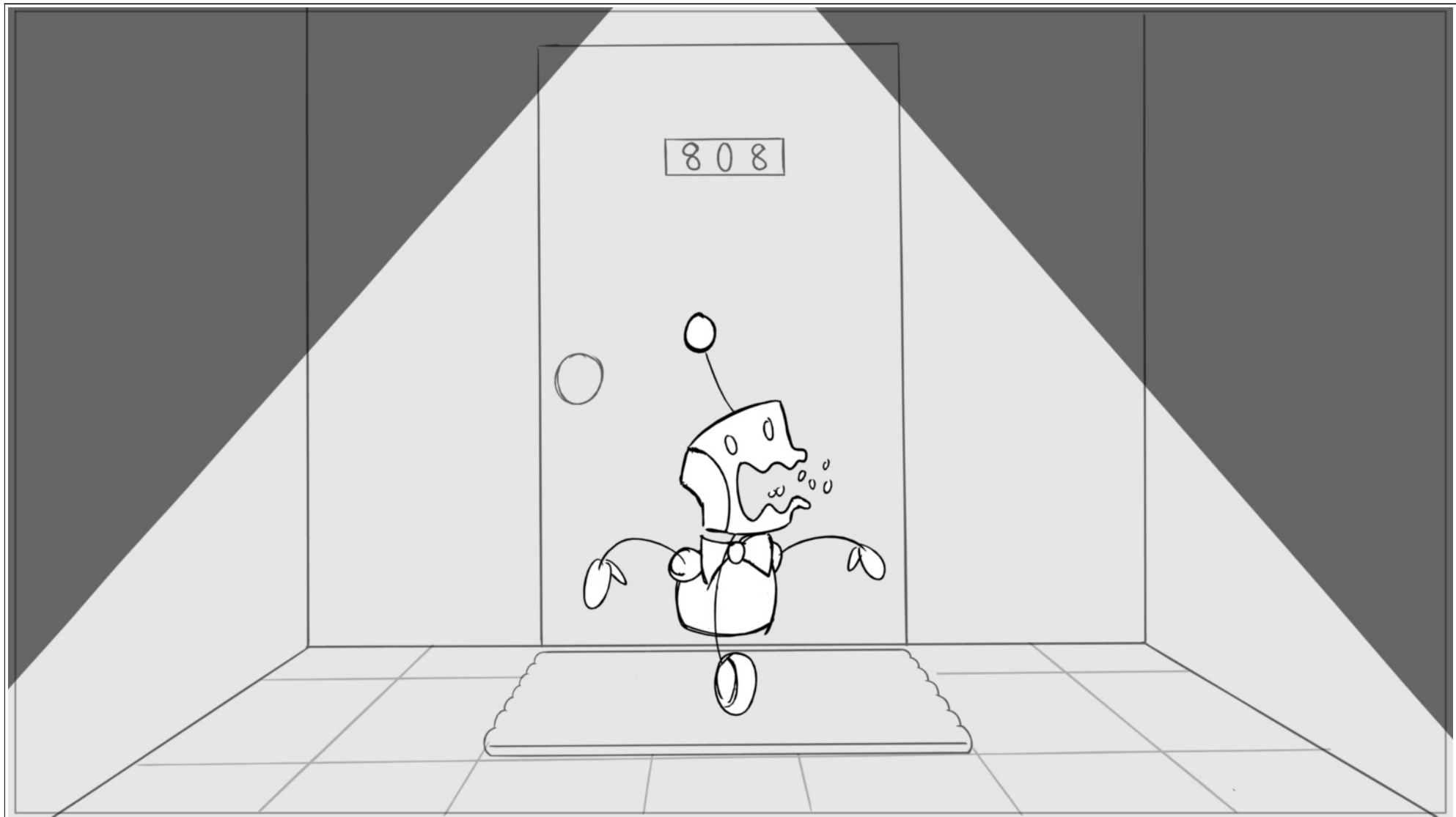

Scene	Duration	Panel	Duration
1_A_1_A	02:22:18	7	01:00

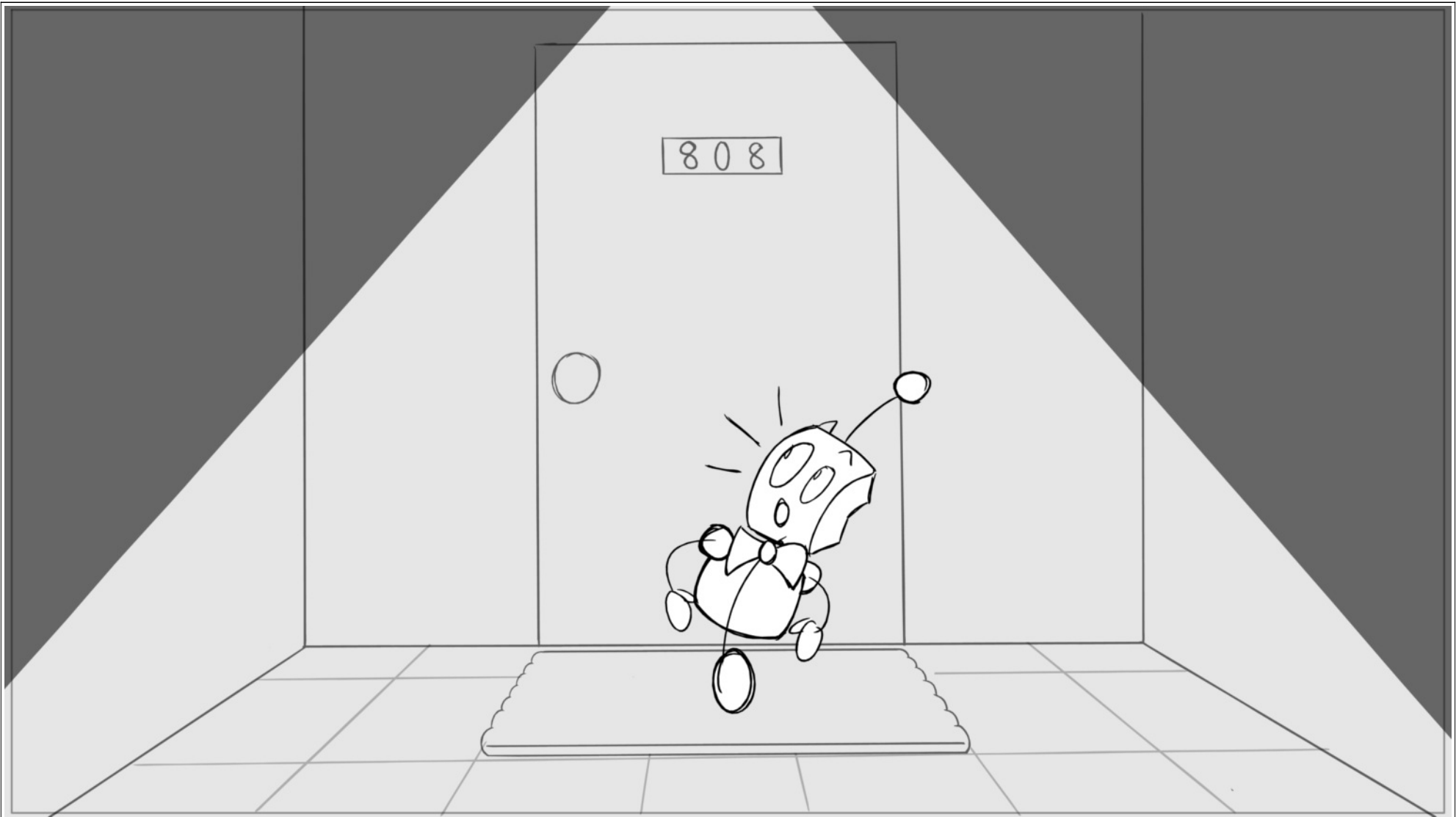

Scene	Duration	Panel	Duration
1_A_1_A	02:22:18	8	01:00



Scene	Duration	Panel	Duration
1_A_1_A	02:22:18	9	01:00

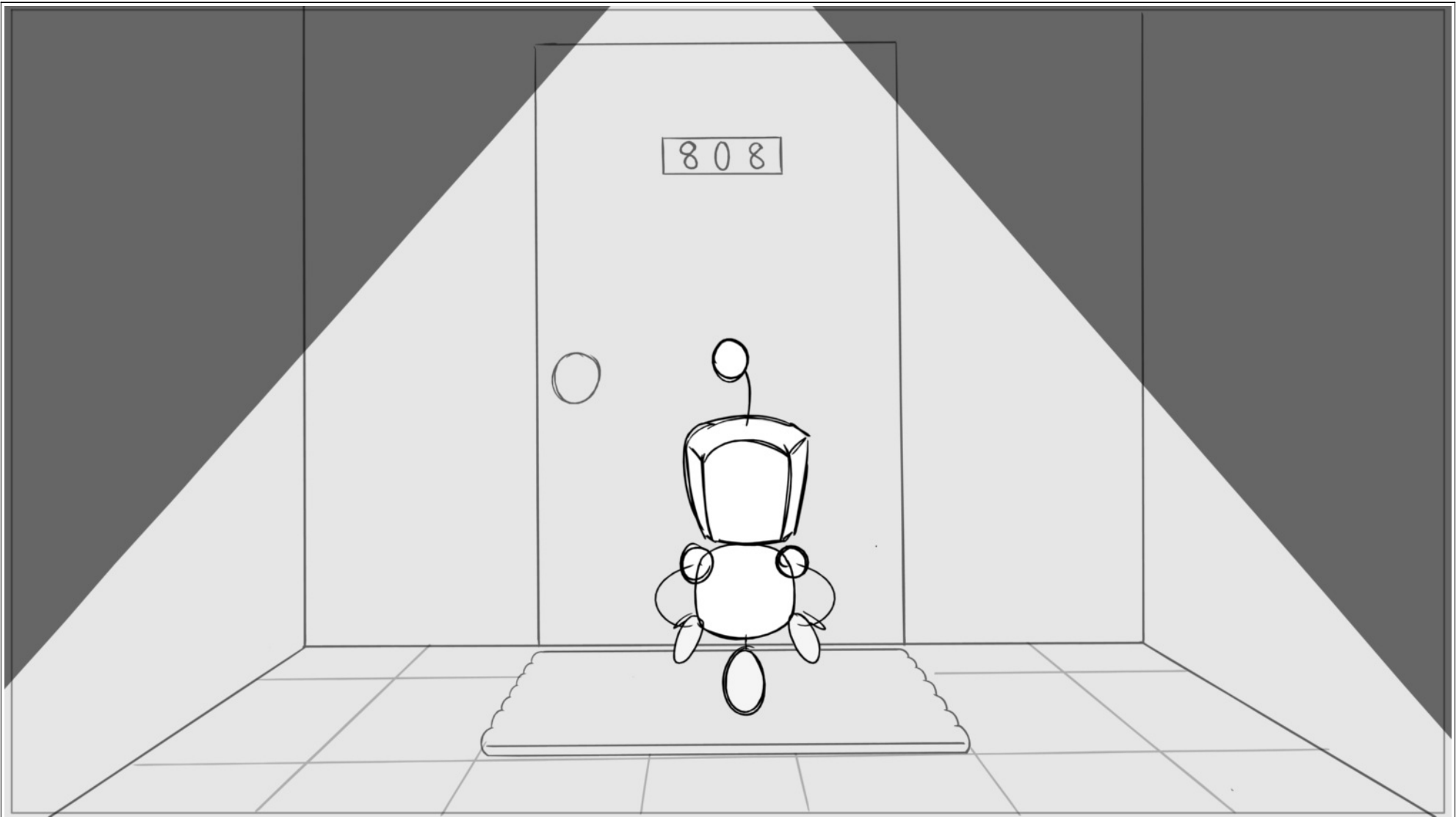

Scene	Duration	Panel	Duration
1_A_1_A	02:22:18	10	02:00

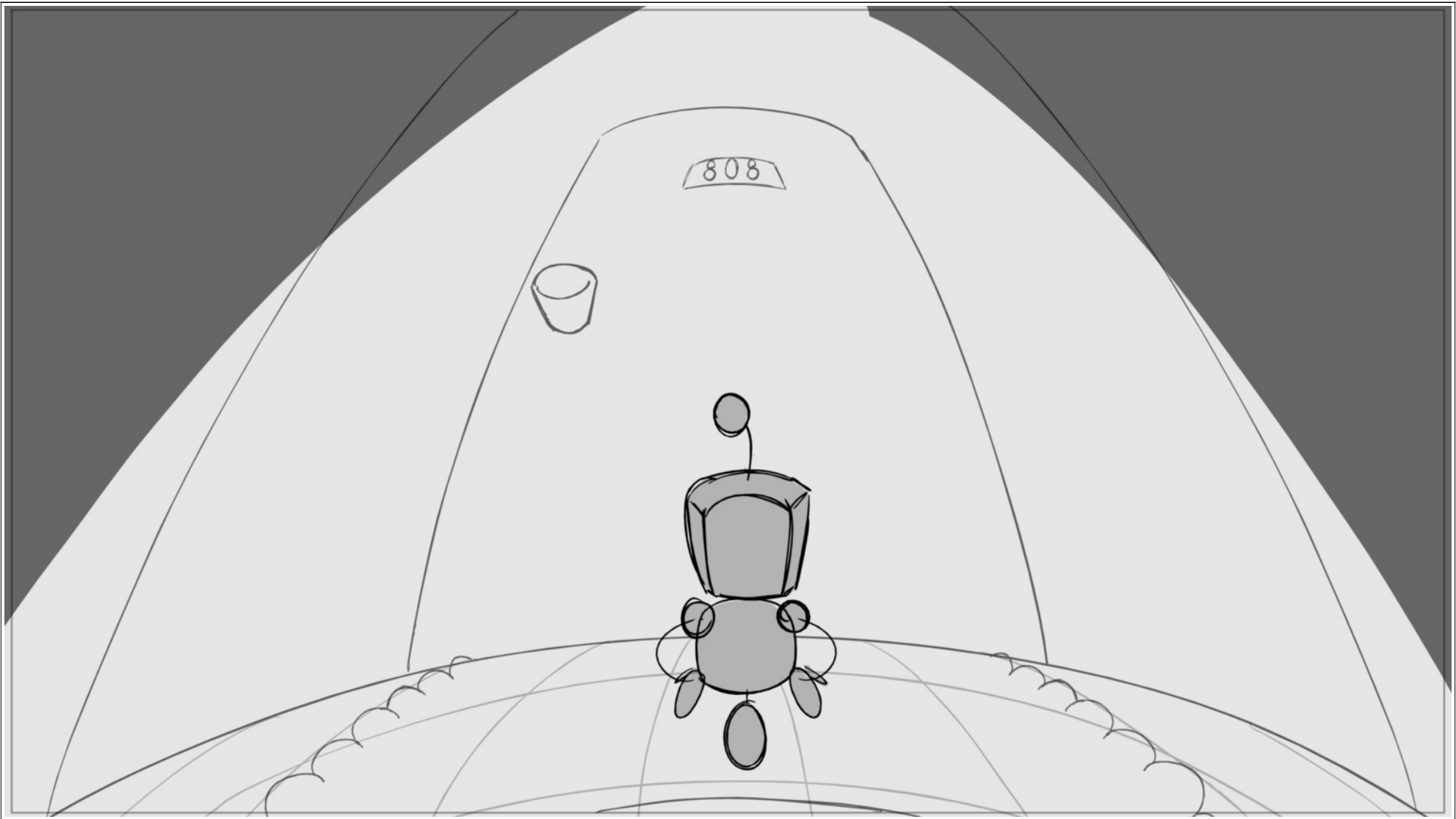

Scene	Duration	Panel	Duration
1_A_1_A	02:22:18	11	01:00

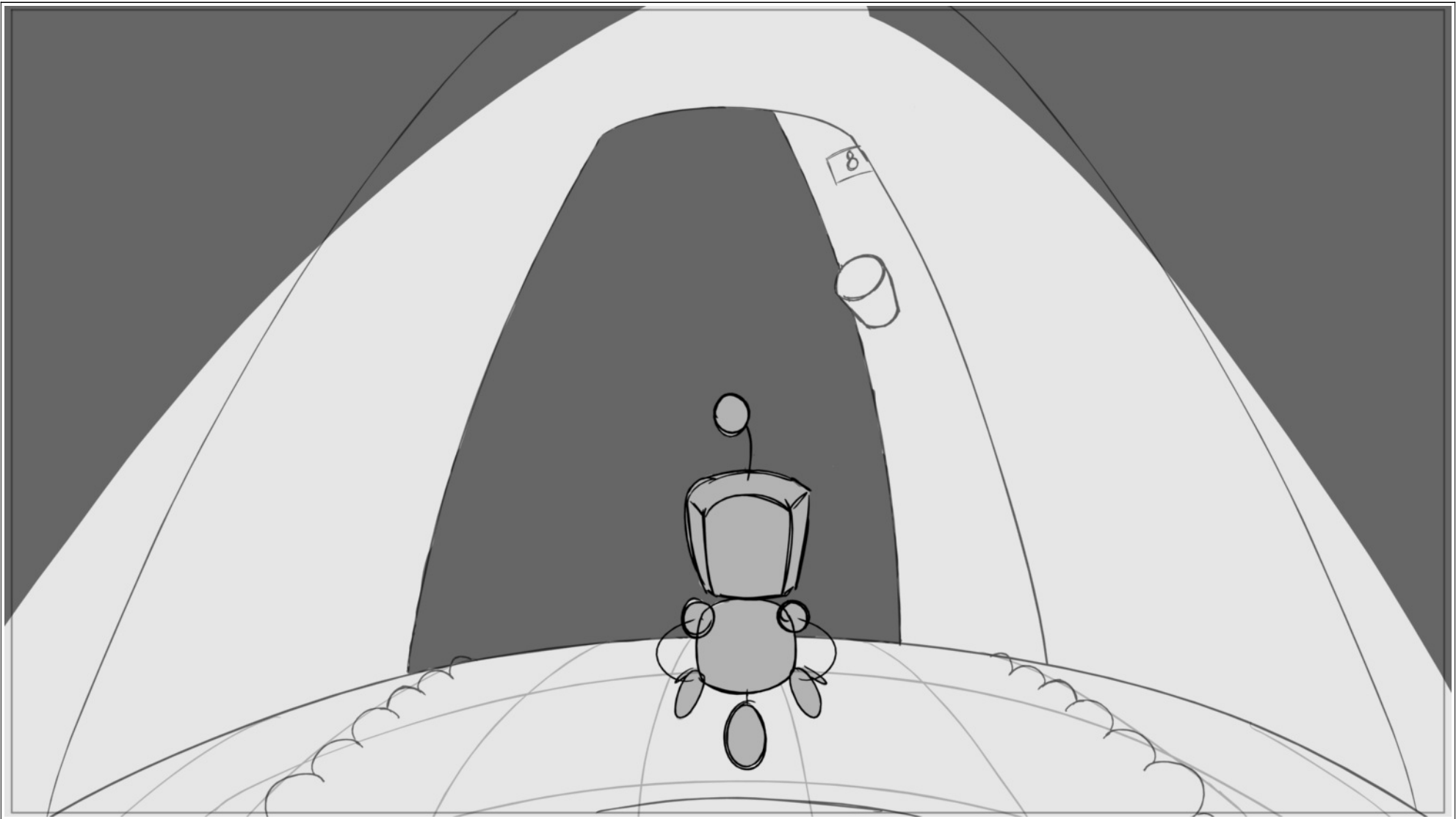

Scene	Duration	Panel	Duration
1_A_1_A	02:22:18	12	01:00

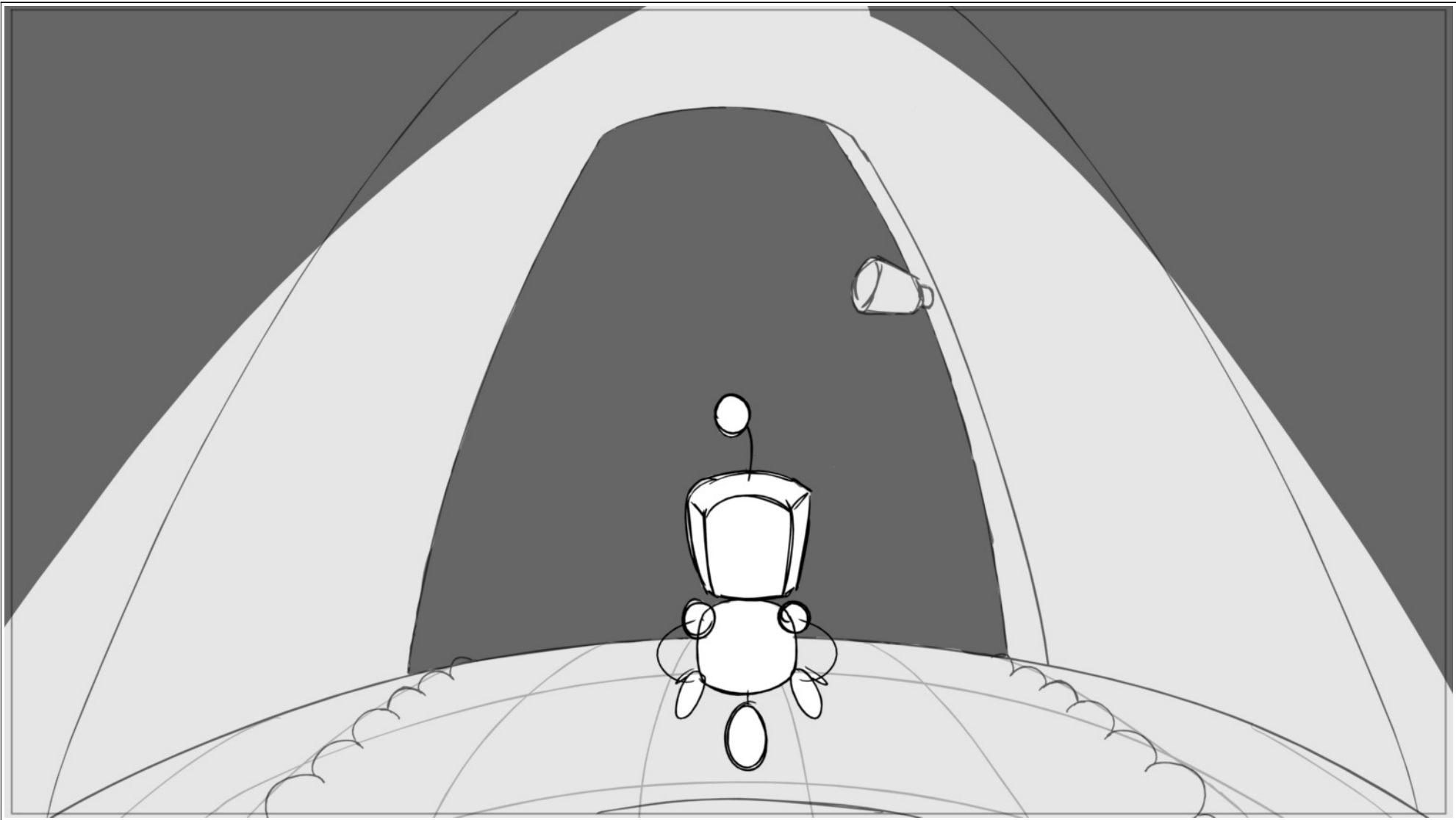

Scene	Duration	Panel	Duration
1_A_1_A	02:22:18	13	02:00

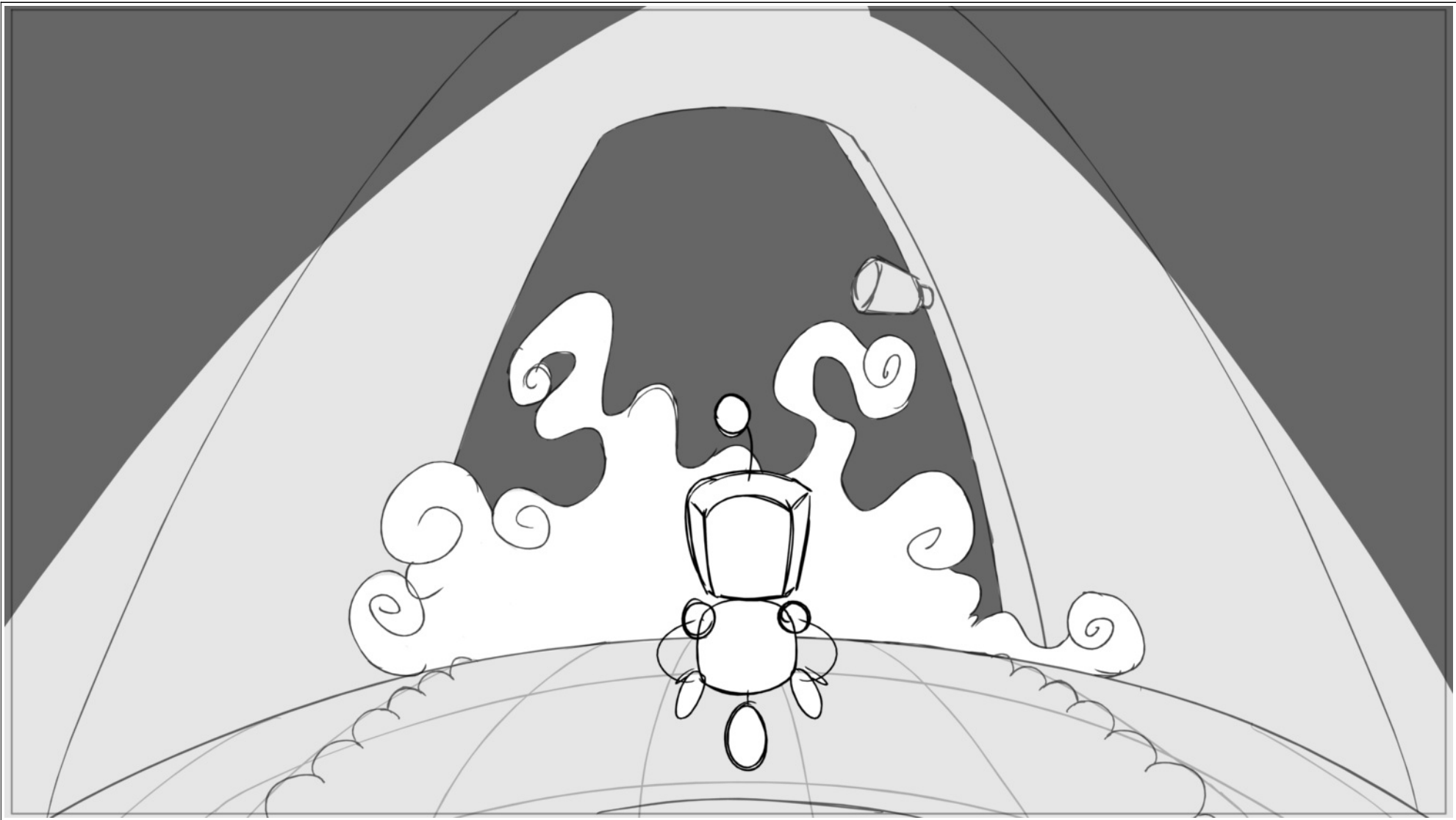

Scene	Duration	Panel	Duration
1_A_1_A	02:22:18	14	02:00

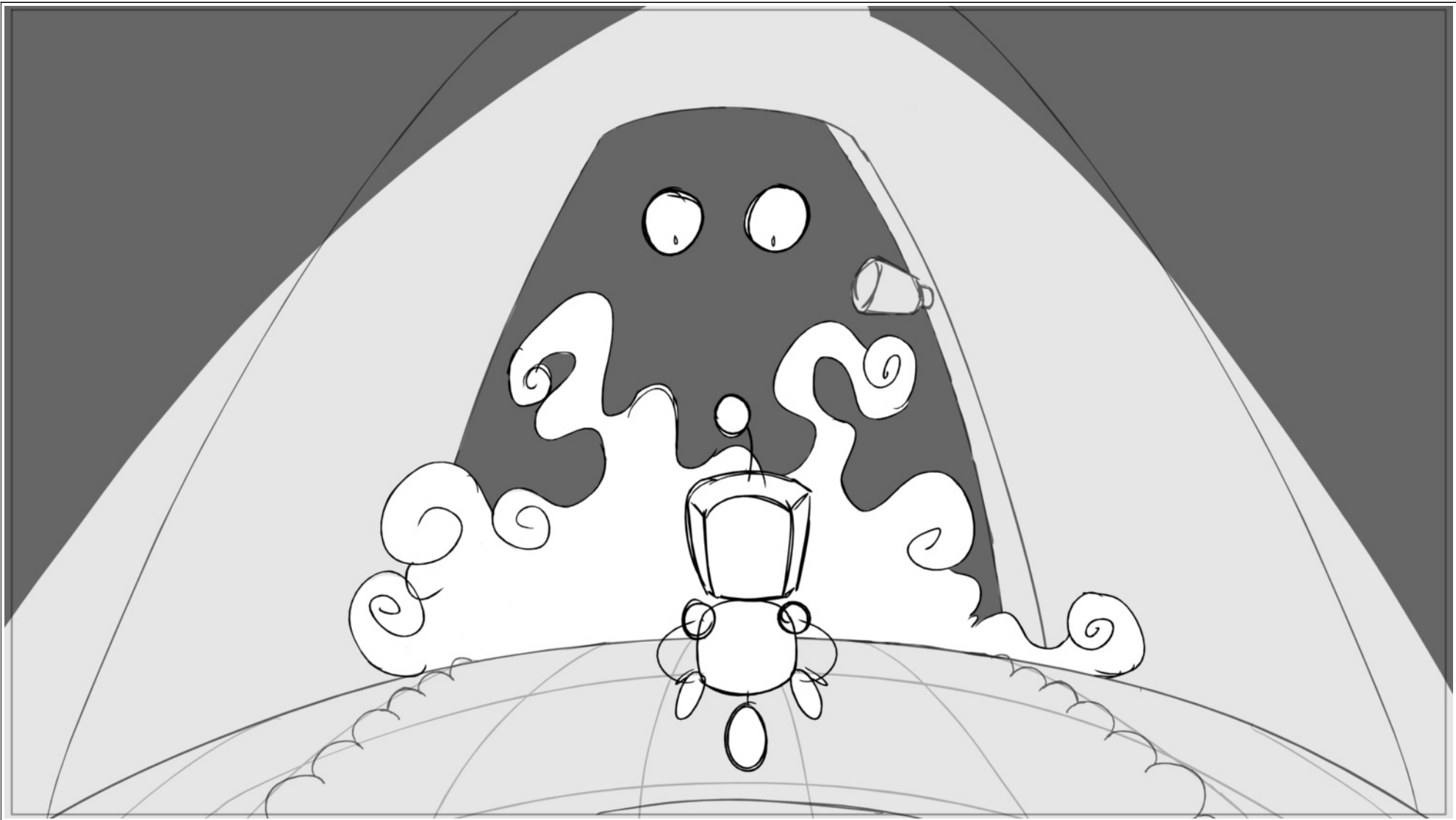

Scene	Duration	Panel	Duration
1_A_1_A	02:22:18	15	01:12

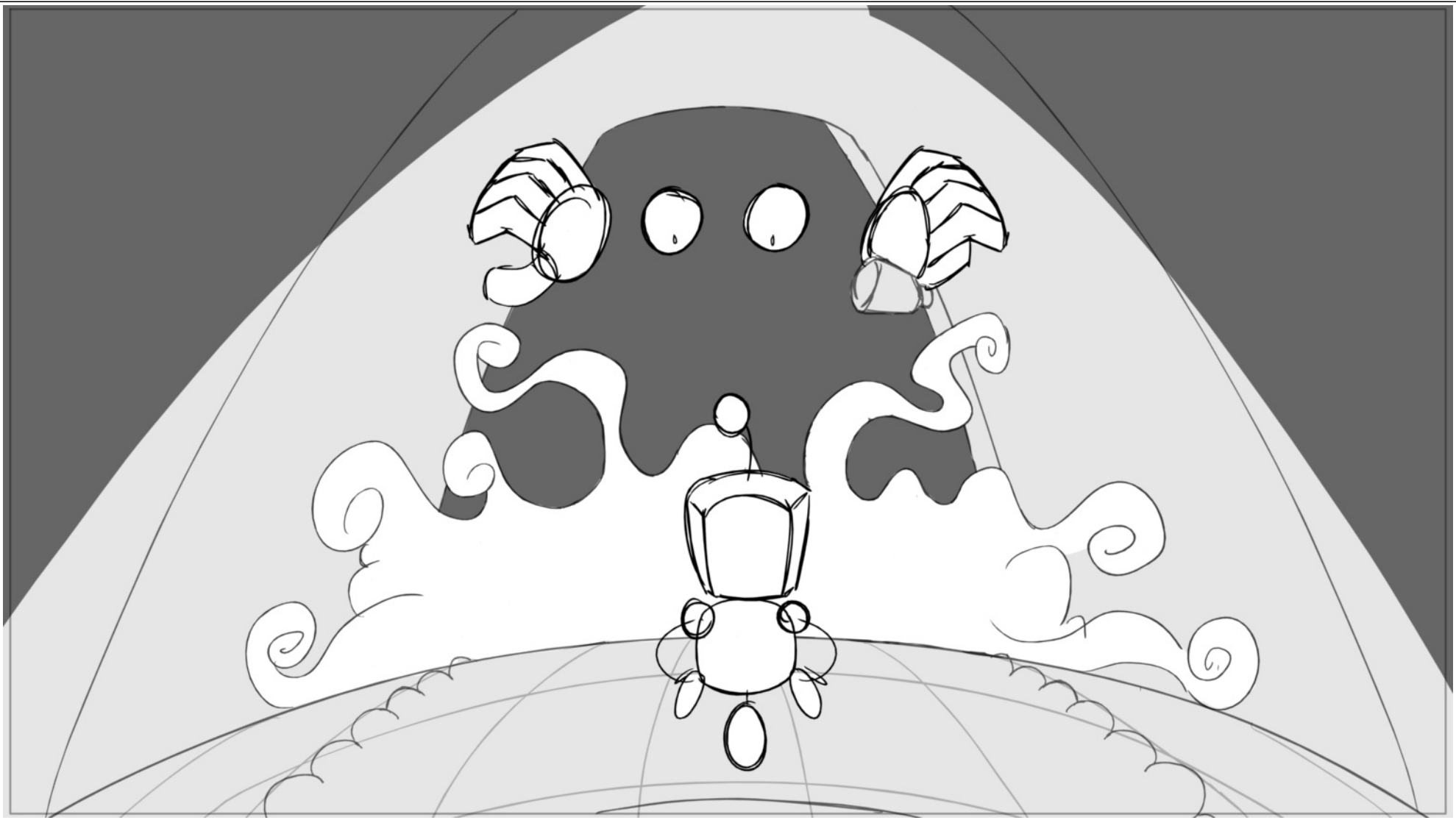

Scene	Duration	Panel	Duration
1_A_1_A	02:22:18	16	02:00

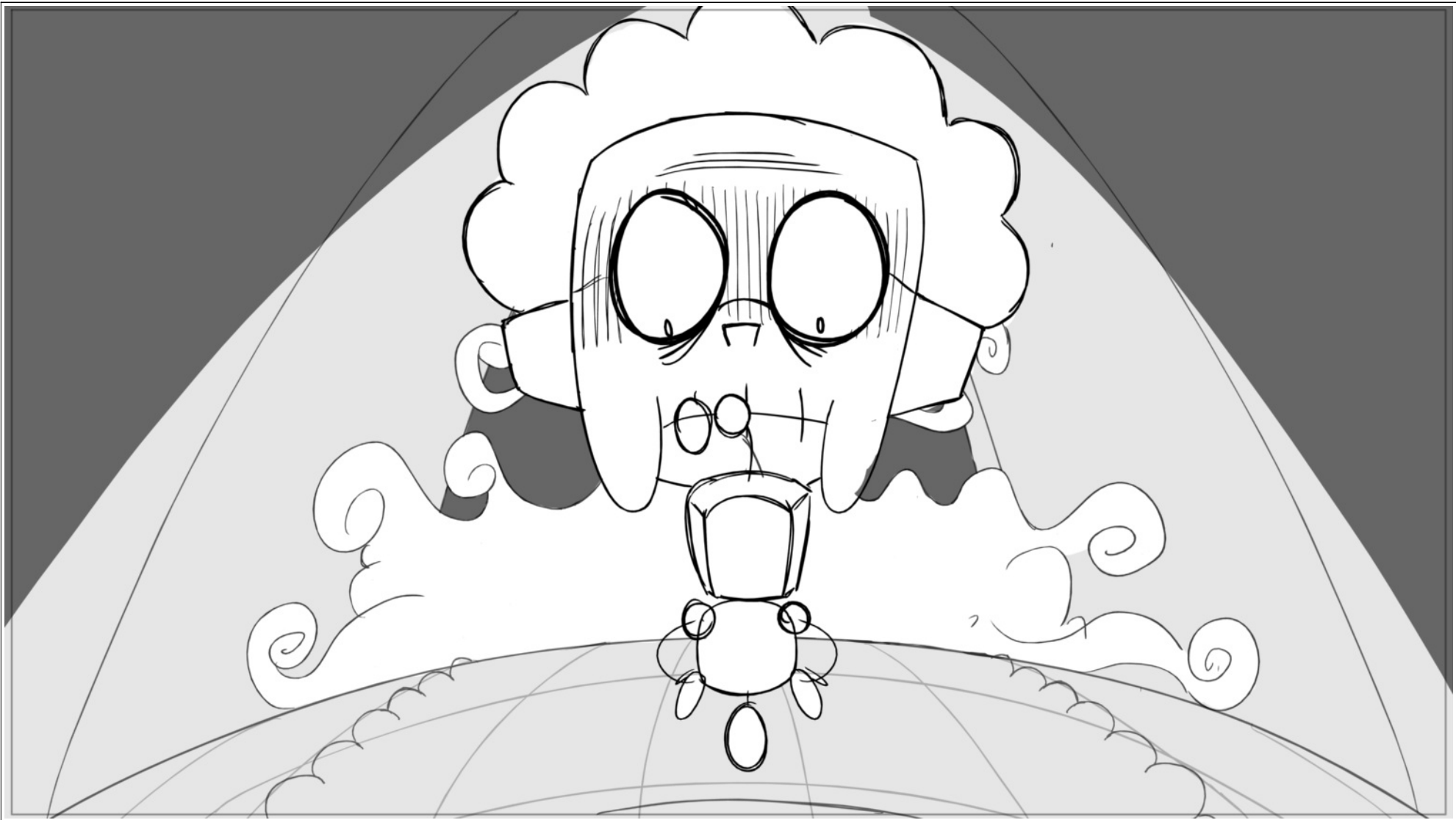

Scene	Duration	Panel	Duration
1_A_1_A	02:22:18	17	02:00

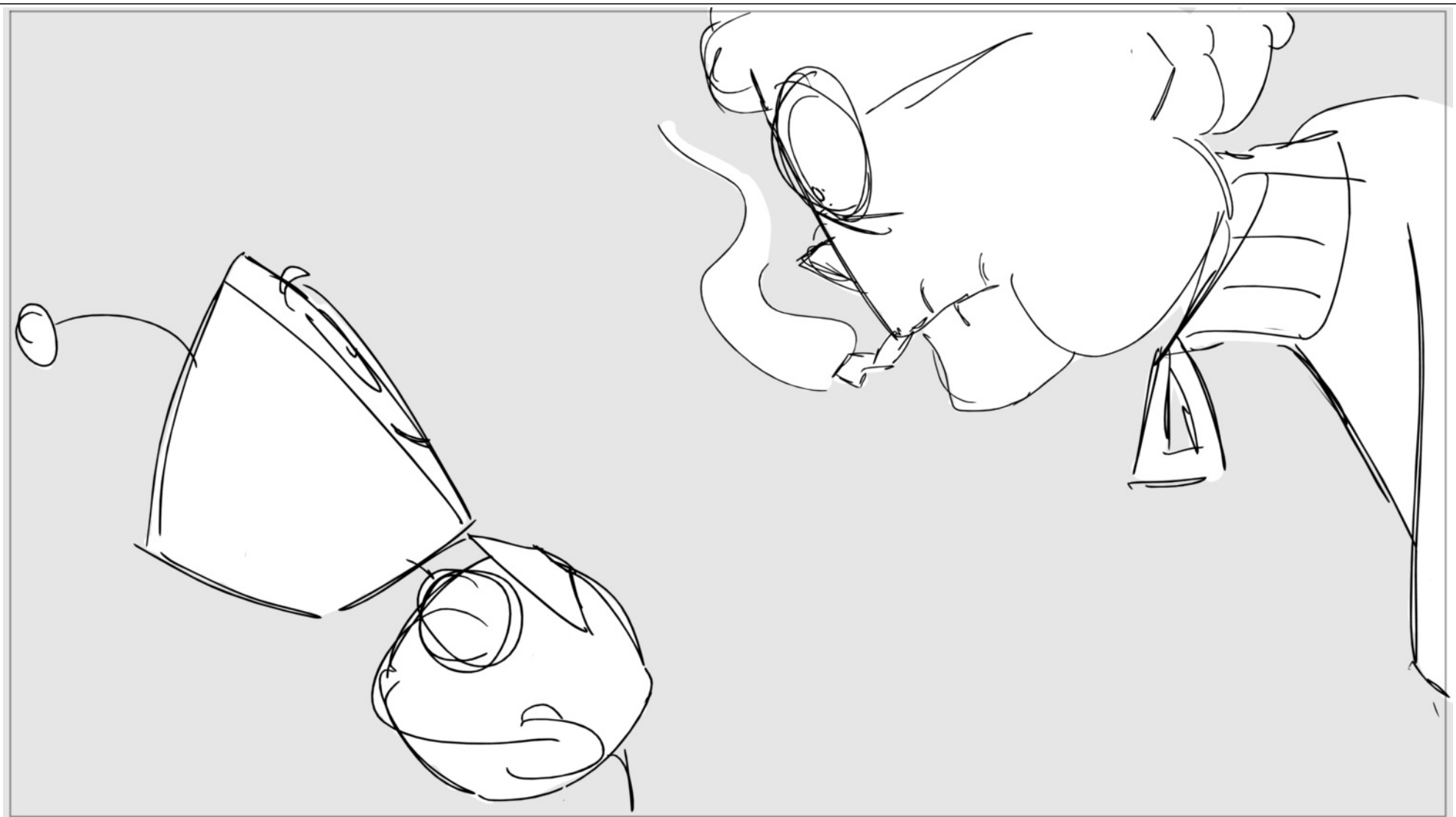

Scene	Duration	Panel	Duration
1_A_1_A	02:22:18	18	01:00

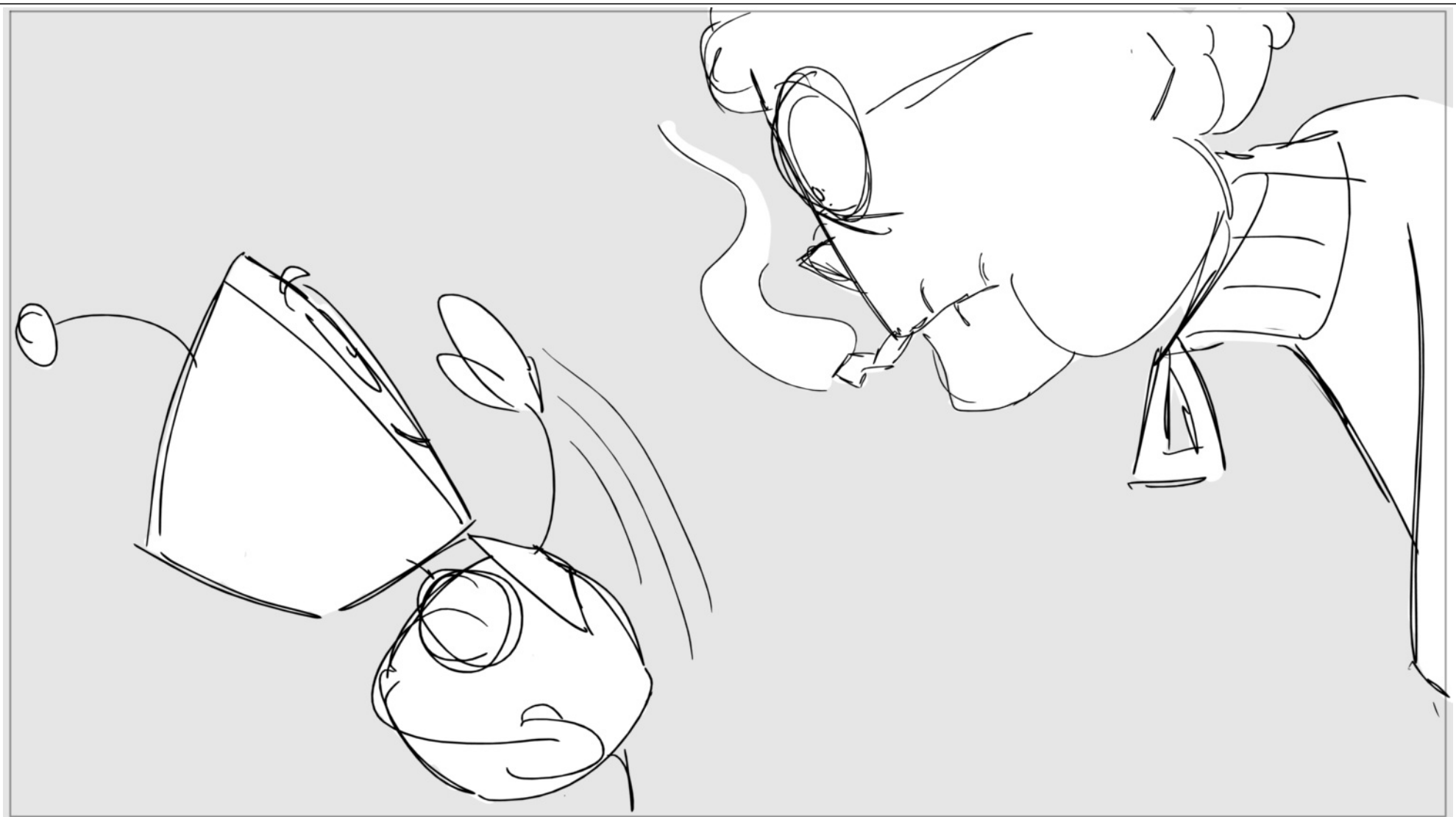

Scene	Duration	Panel	Duration
1_A_1_A	02:22:18	19	01:00

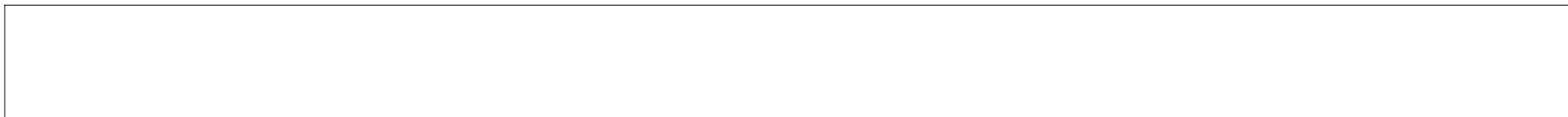
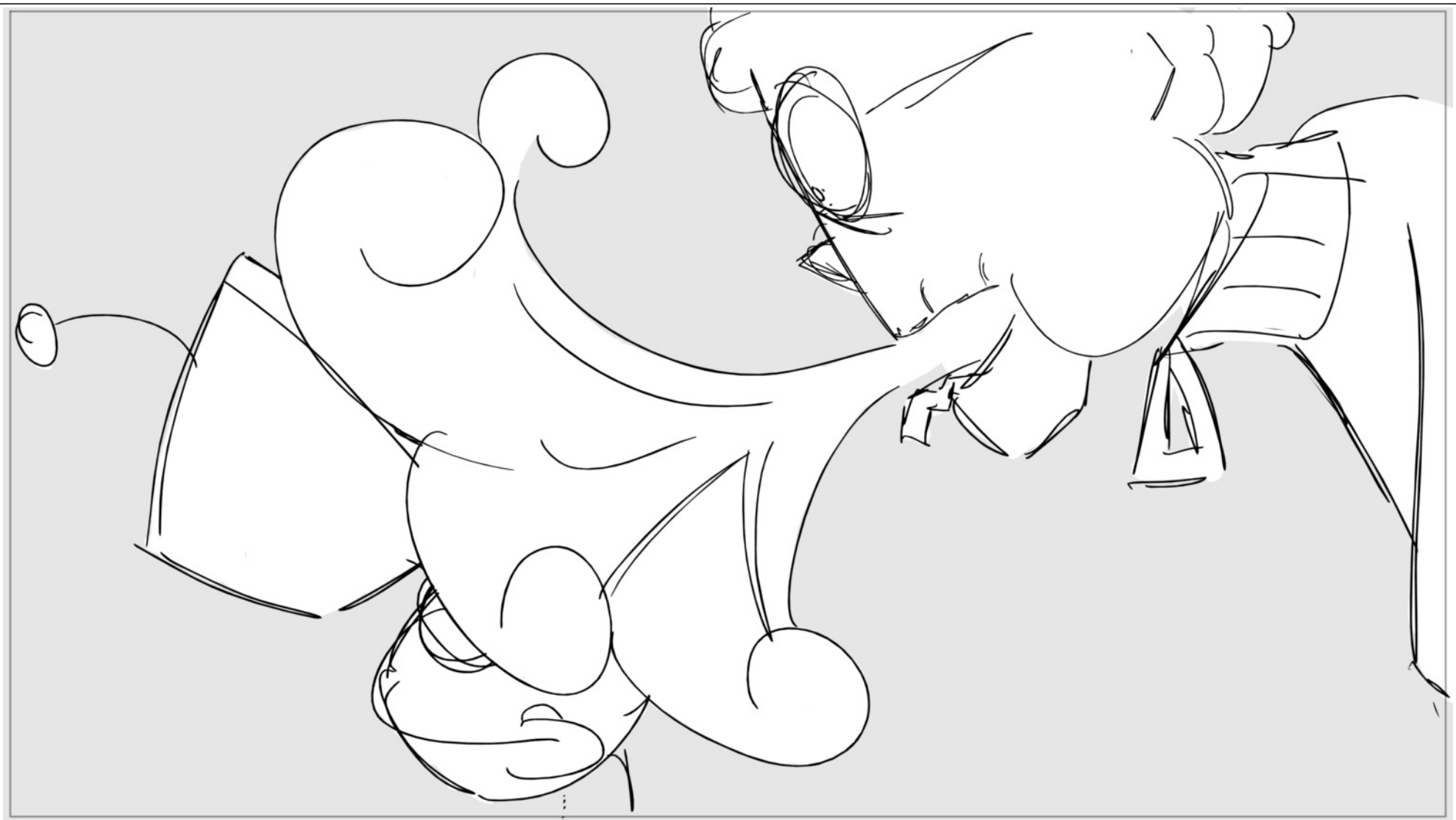

Scene	Duration	Panel	Duration
1_A_1_A	02:22:18	20	00:18

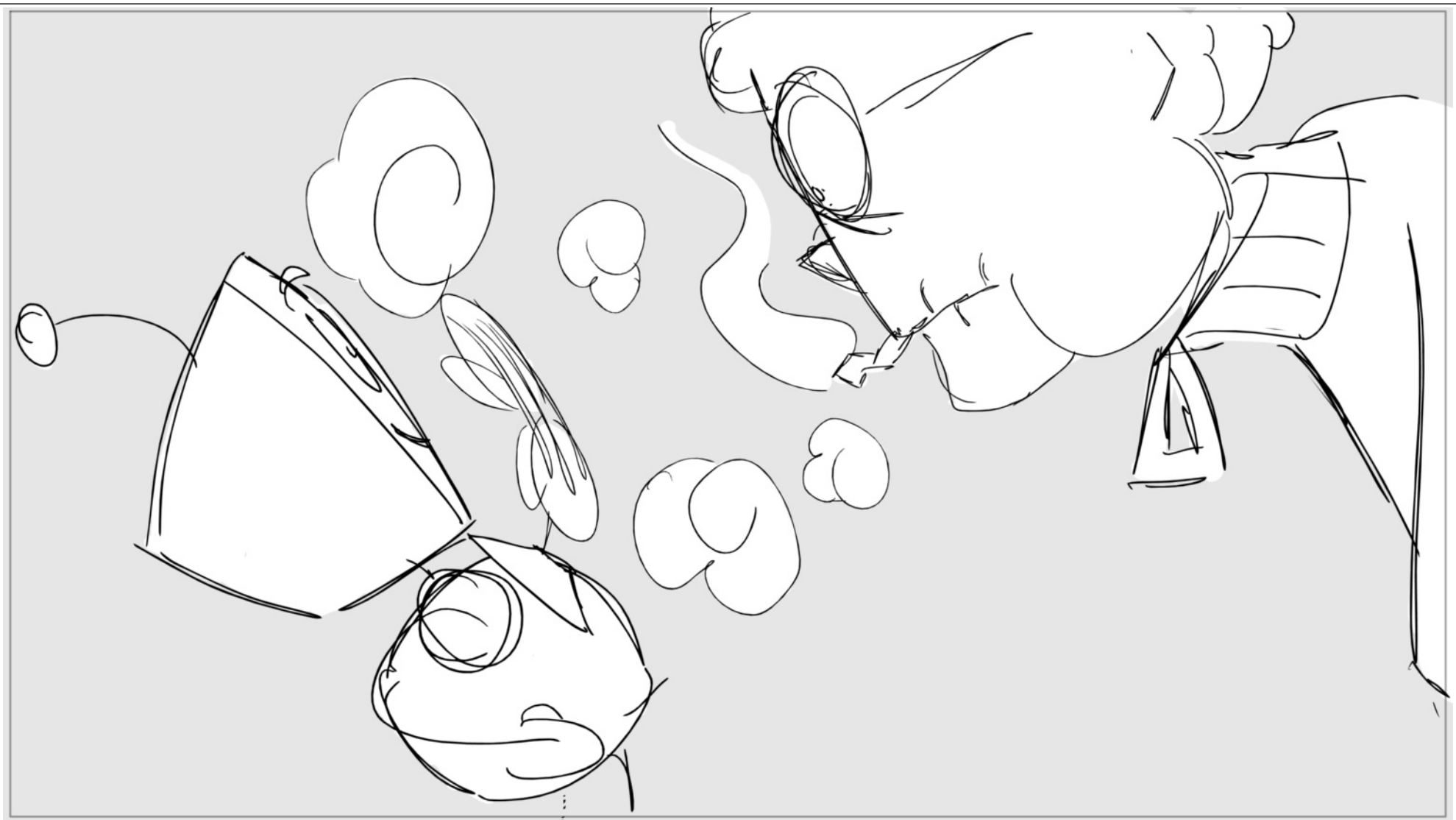

Scene	Duration	Panel	Duration
1_A_1_A	02:22:18	21	02:00

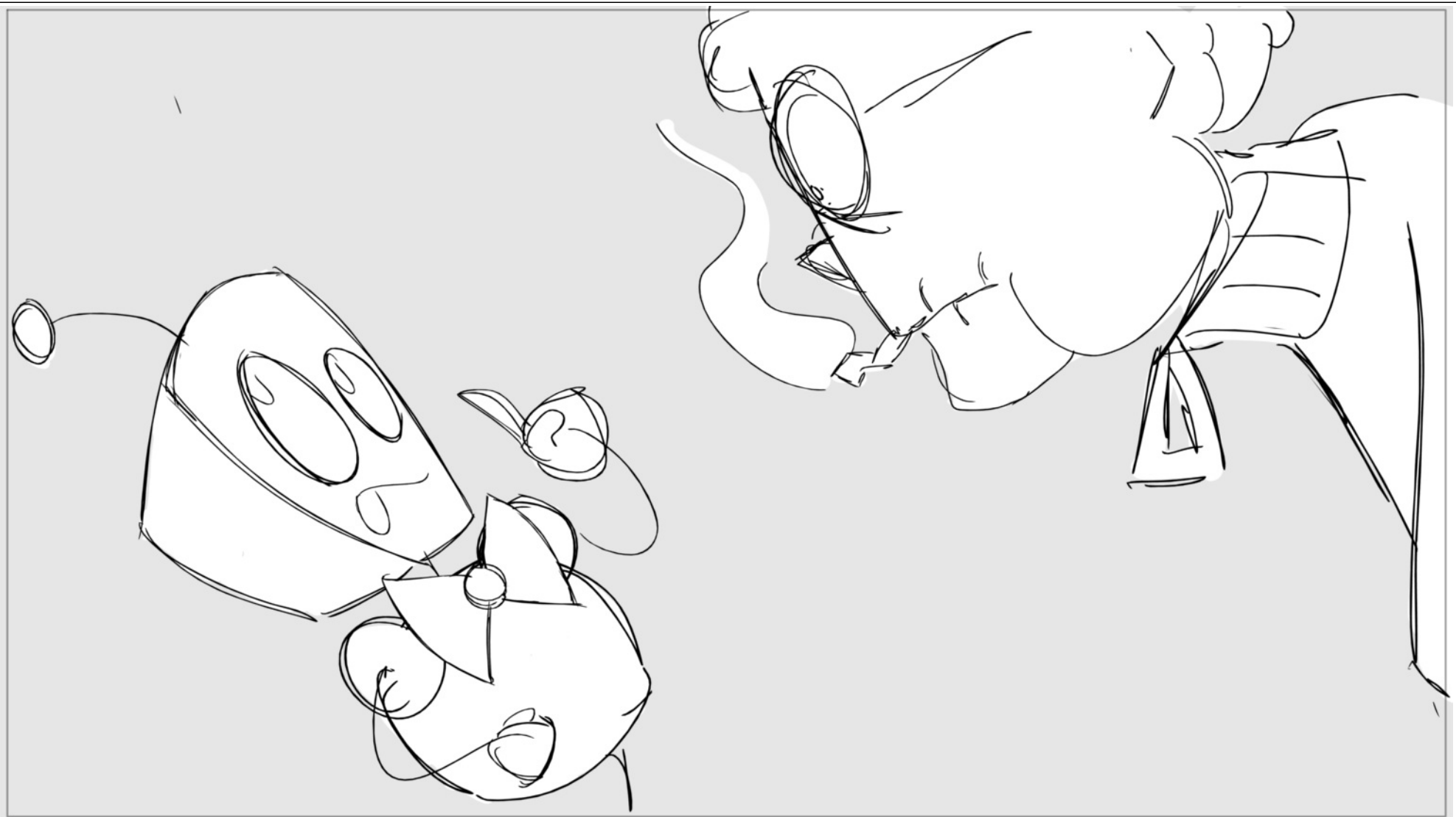

Scene	Duration	Panel	Duration
1_A_1_A	02:22:18	22	01:12

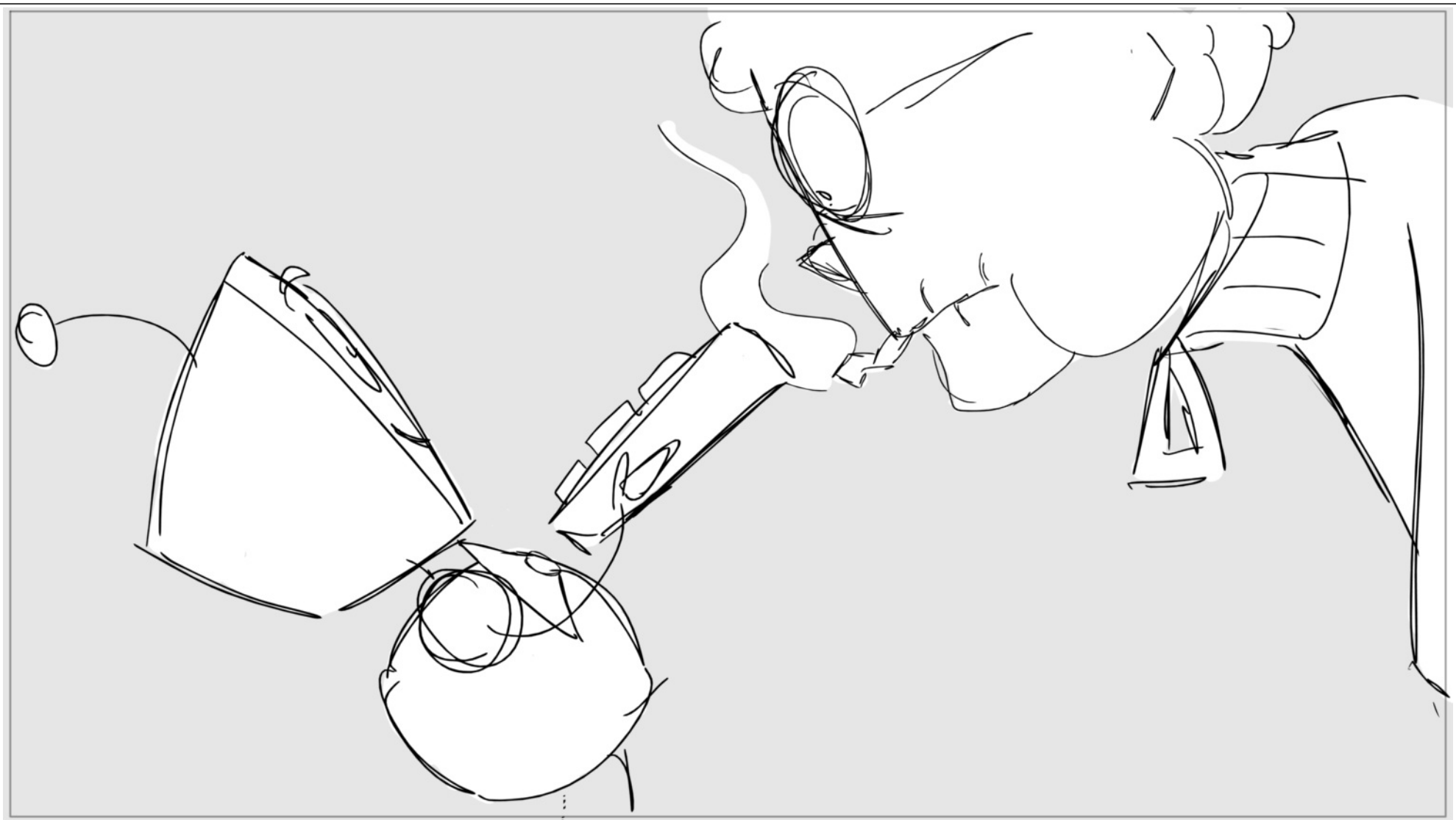

Scene	Duration	Panel	Duration
1_A_1_A	02:22:18	23	02:12

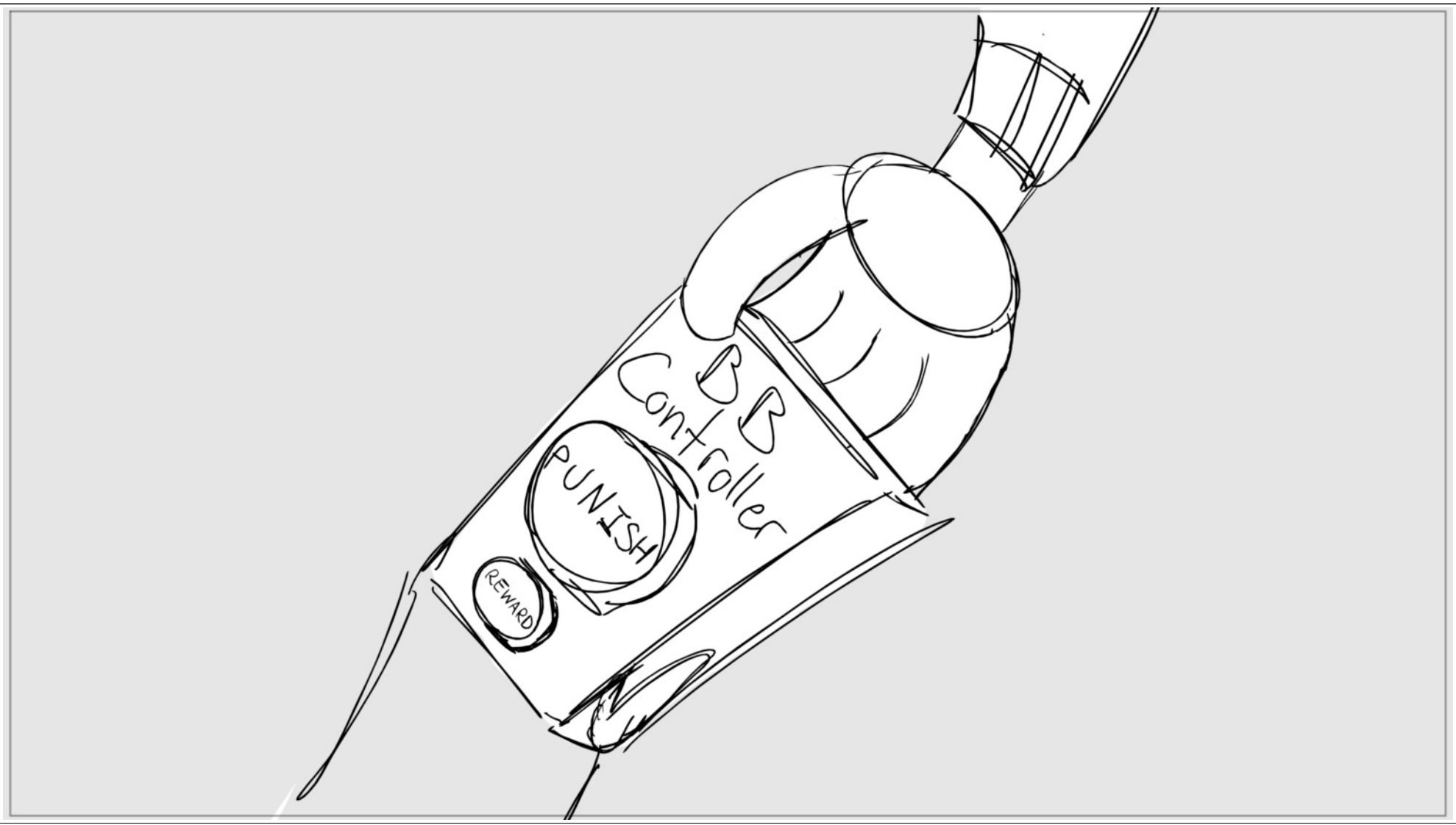

Scene	Duration	Panel	Duration
1_A_1_A	02:22:18	24	02:00

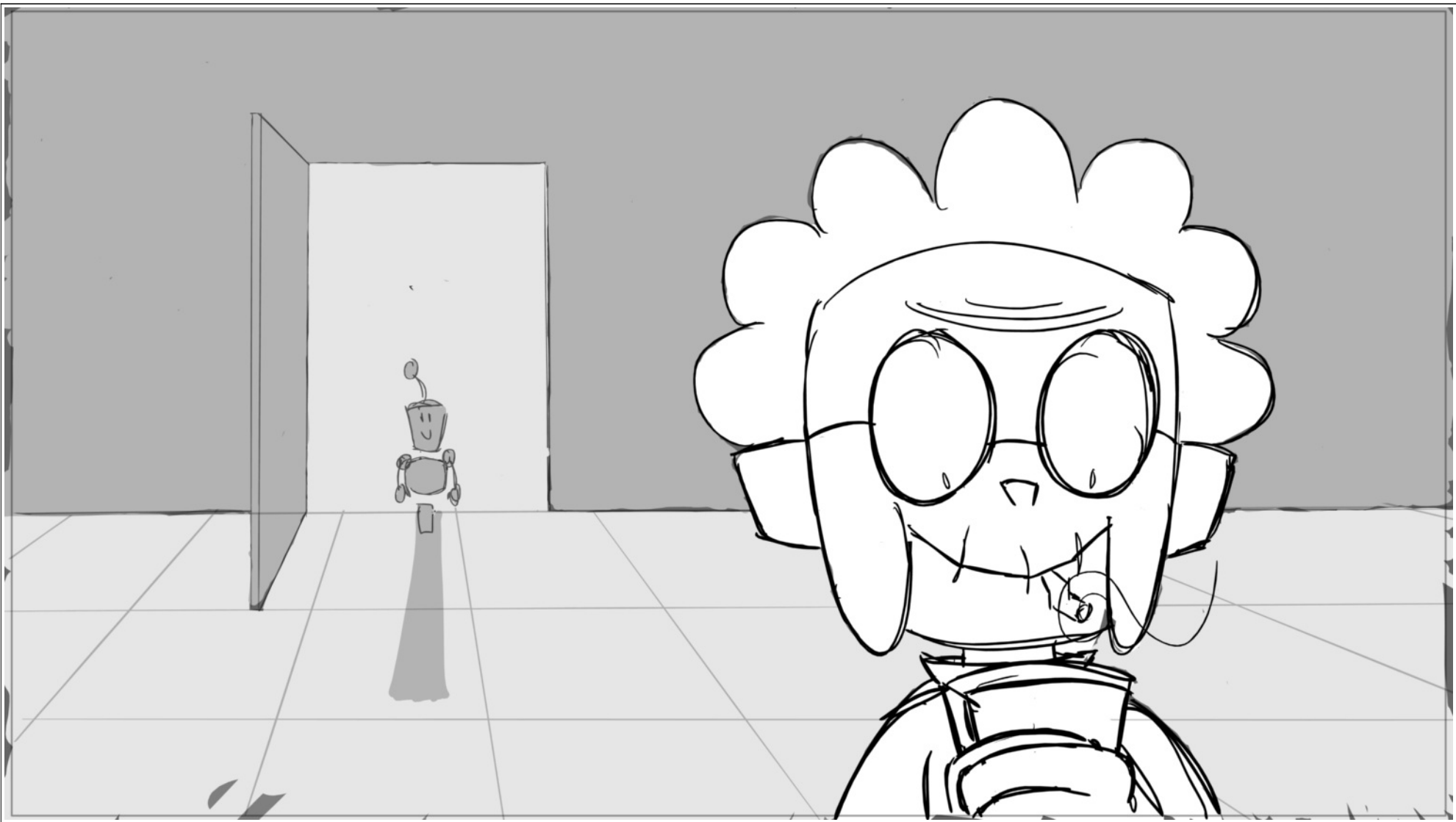

Scene	Duration	Panel	Duration
1_A_1_A	02:22:18	25	04:00



Scene	Duration	Panel	Duration
1_A_1_A	02:22:18	26	02:00



Scene	Duration	Panel	Duration
1_A_1_A	02:22:18	27	02:12



Scene	Duration	Panel	Duration
1_A_1_A	02:22:18	28	01:12

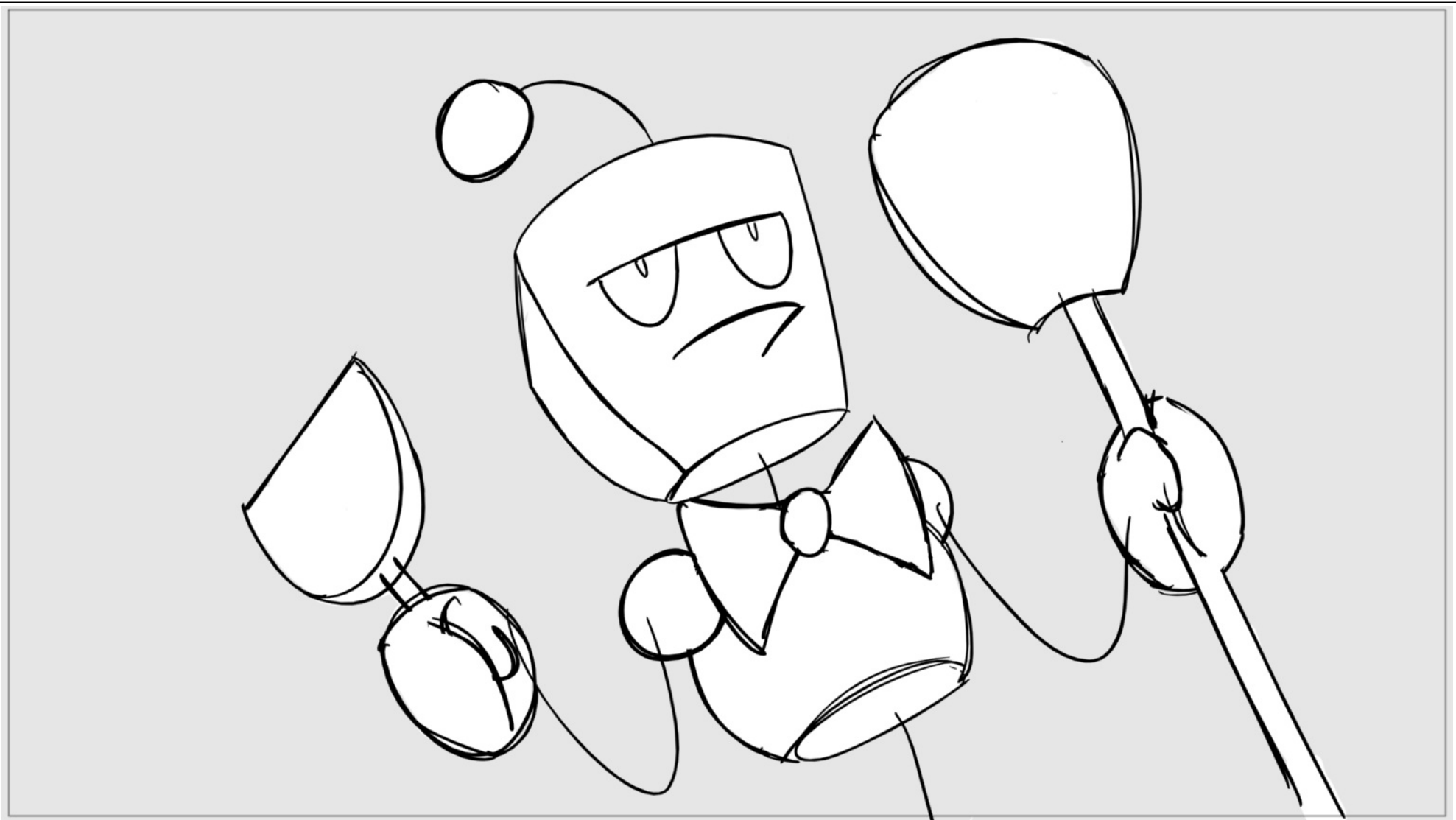

Scene	Duration	Panel	Duration
1_A_1_A	02:22:18	29	03:00

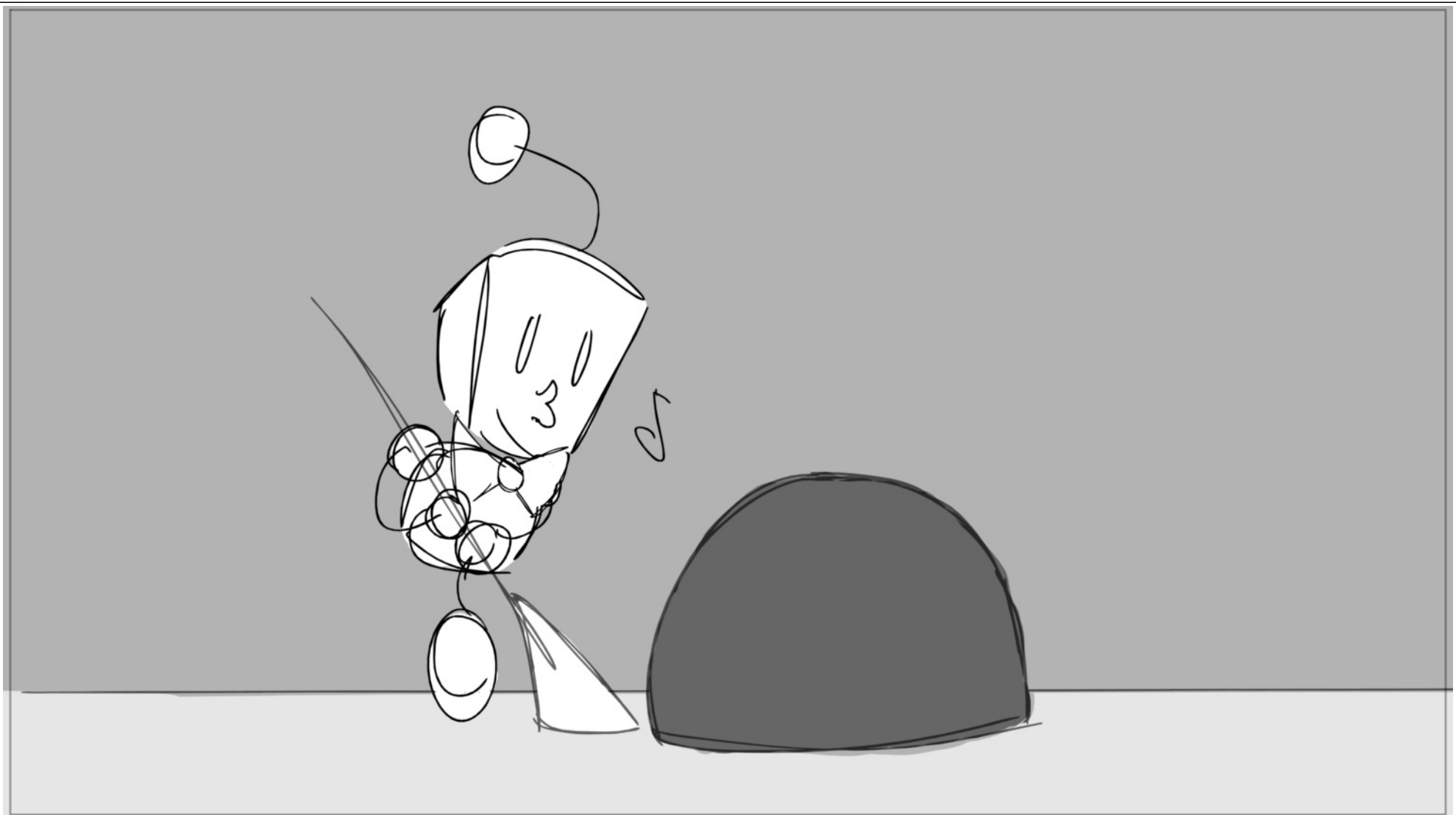

Scene	Duration	Panel	Duration
1_A_1_A	02:22:18	30	01:12

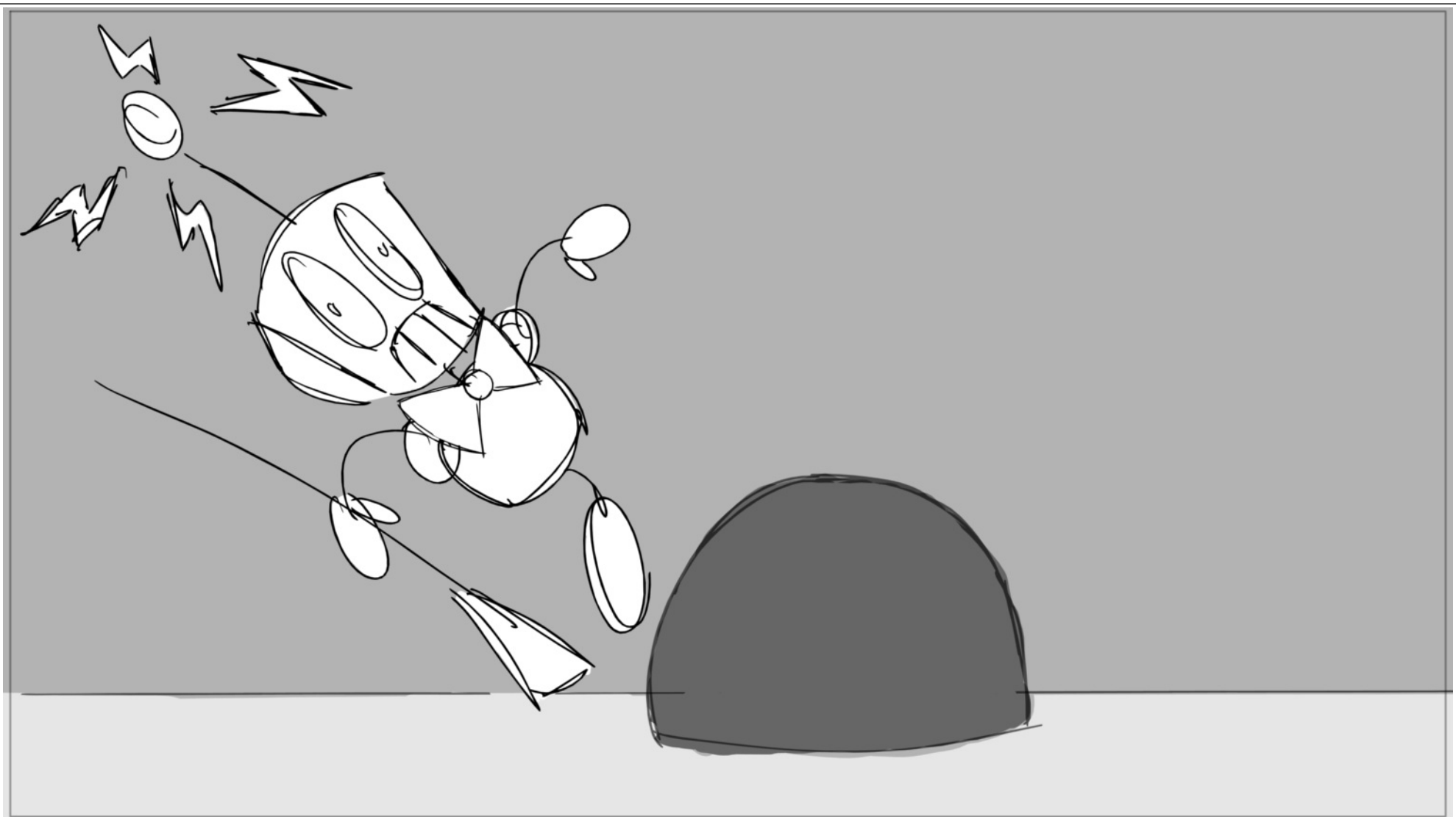

Scene	Duration	Panel	Duration
1_A_1_A	02:22:18	31	02:12

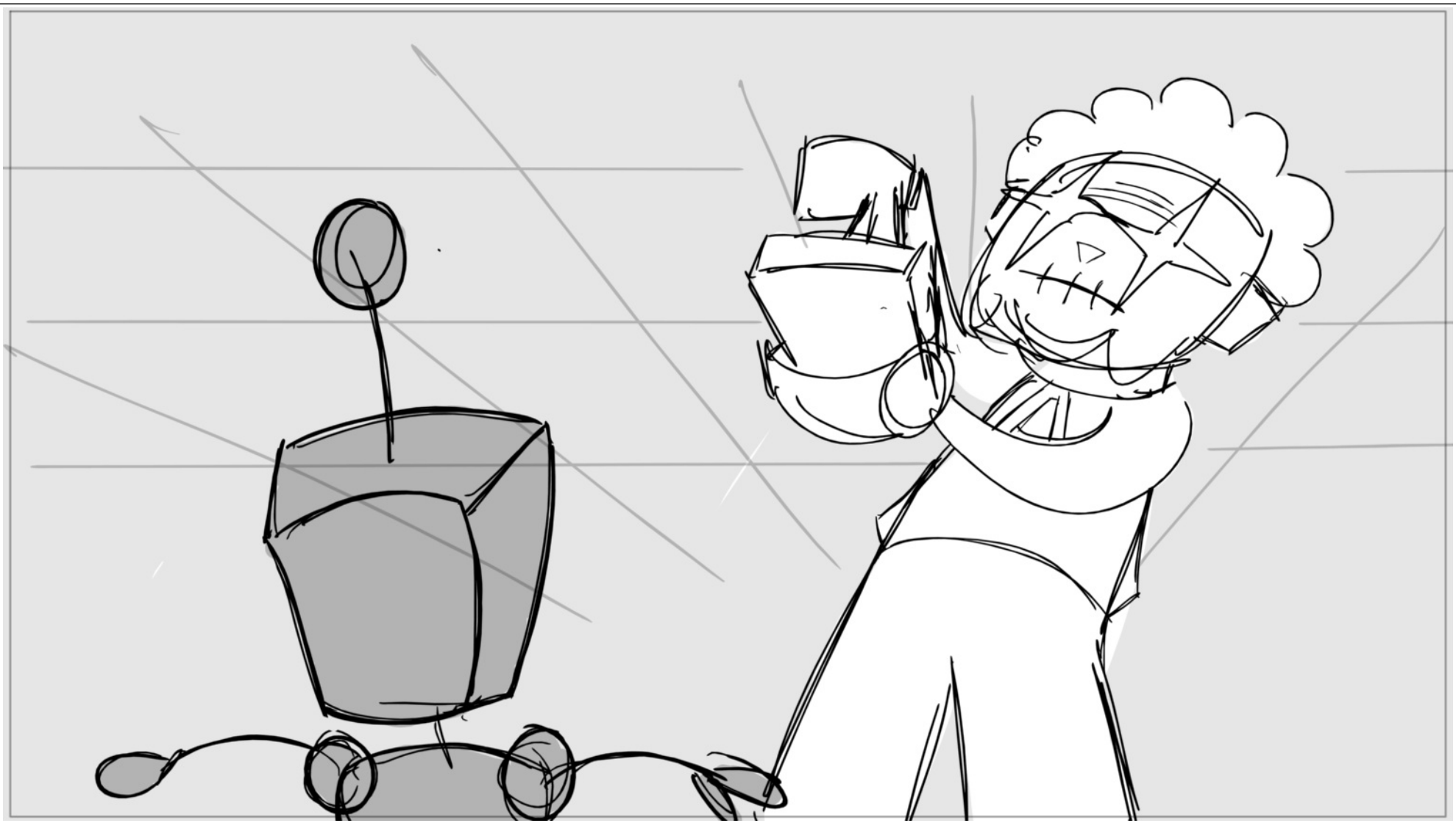

Scene	Duration	Panel	Duration
1_A_1_A	02:22:18	32	02:00



Scene	Duration	Panel	Duration
1_A_1_A	02:22:18	33	03:00

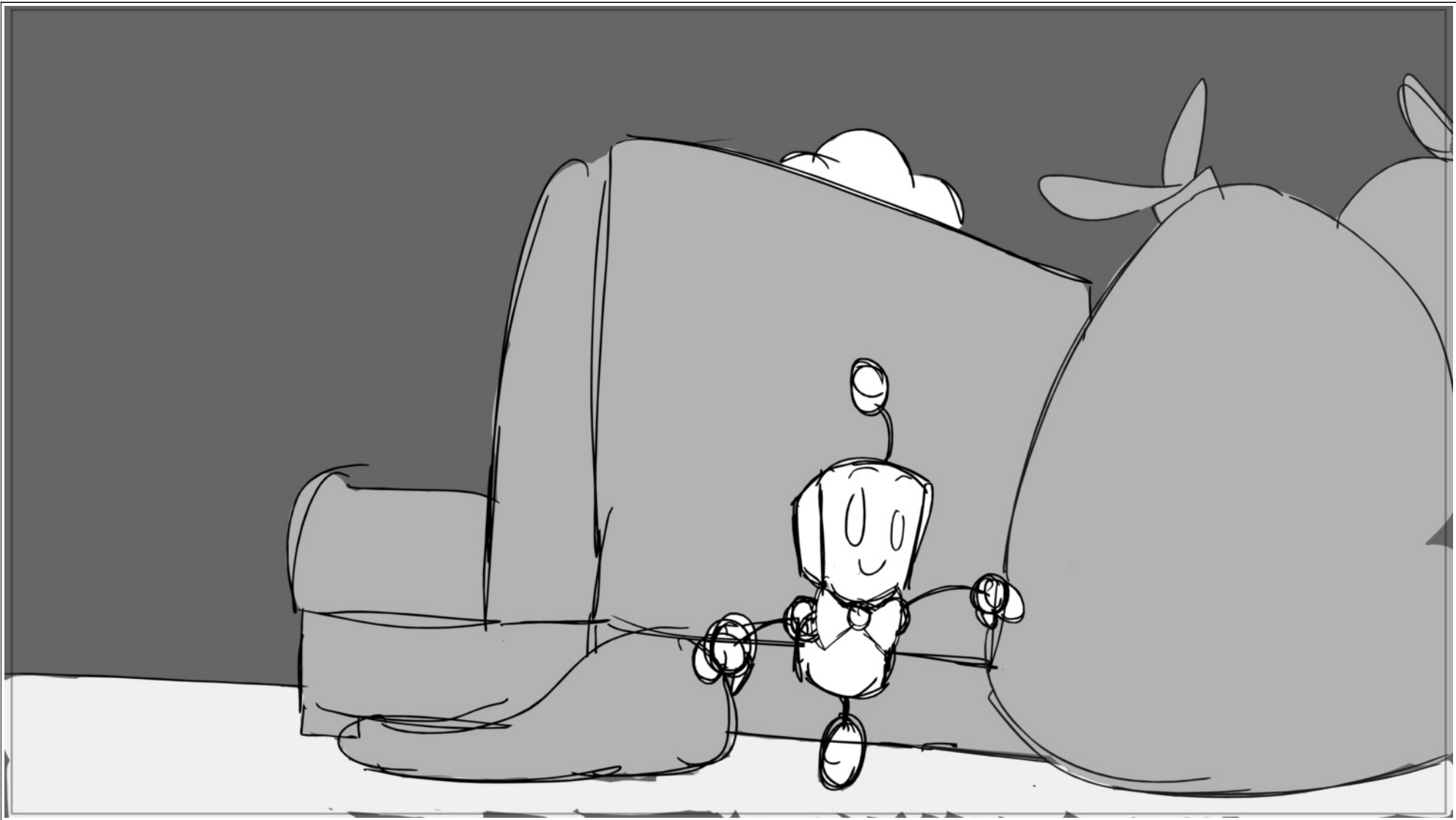

Scene	Duration	Panel	Duration
1_A_1_A	02:22:18	34	01:12

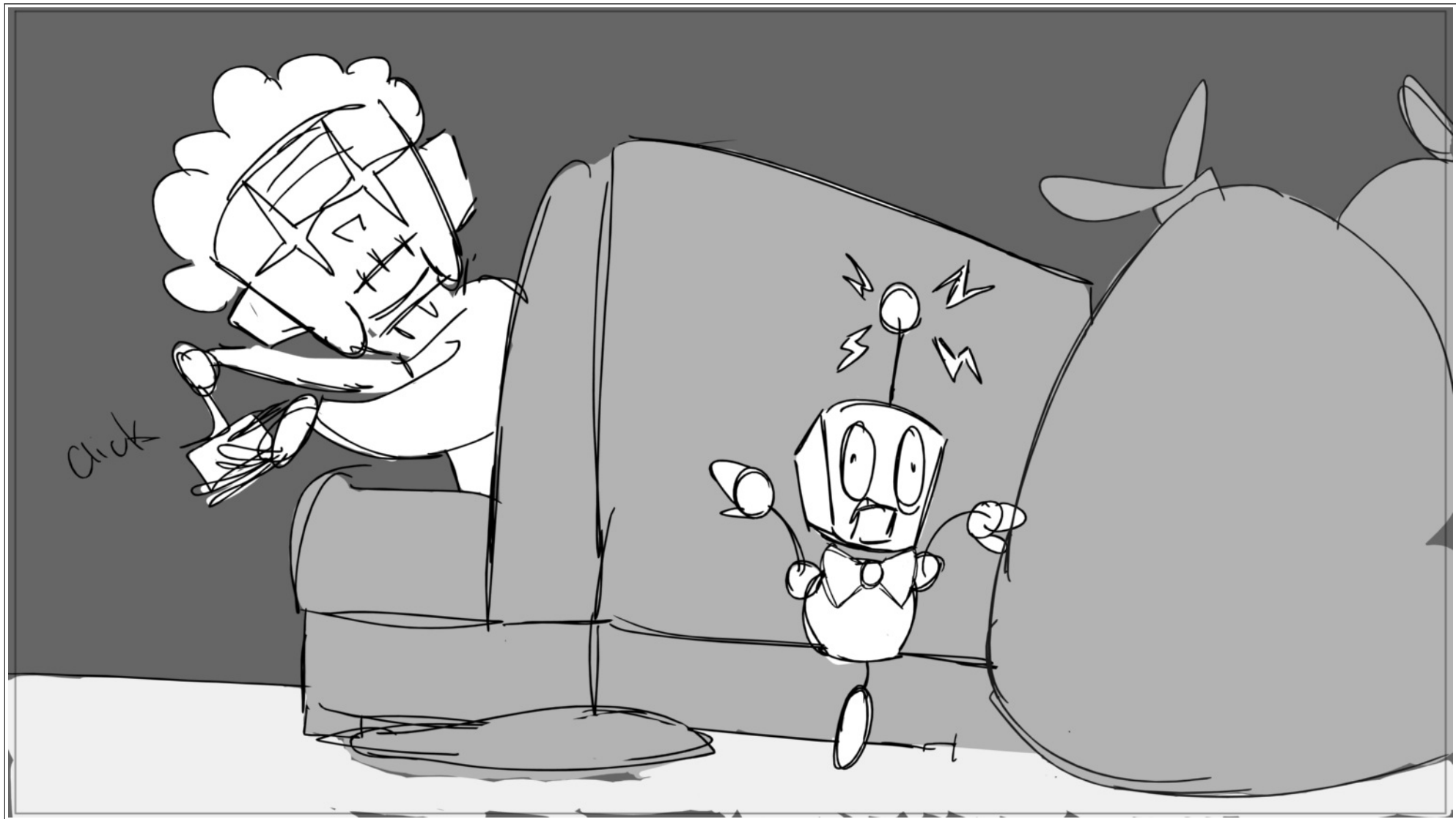

Scene	Duration	Panel	Duration
1_A_1_A	02:22:18	35	03:00

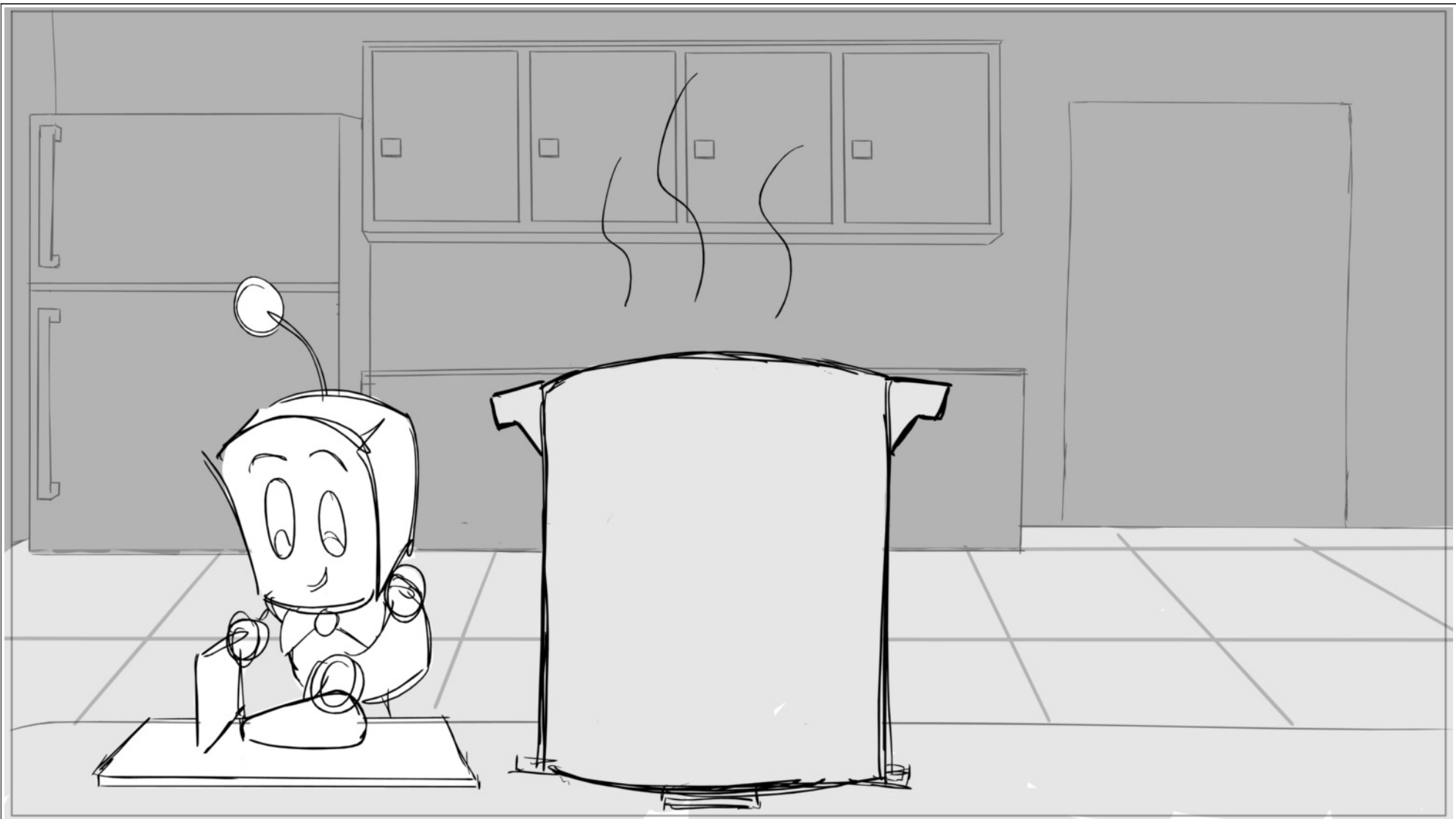

Scene	Duration	Panel	Duration
1_A_1_A	02:22:18	36	01:12

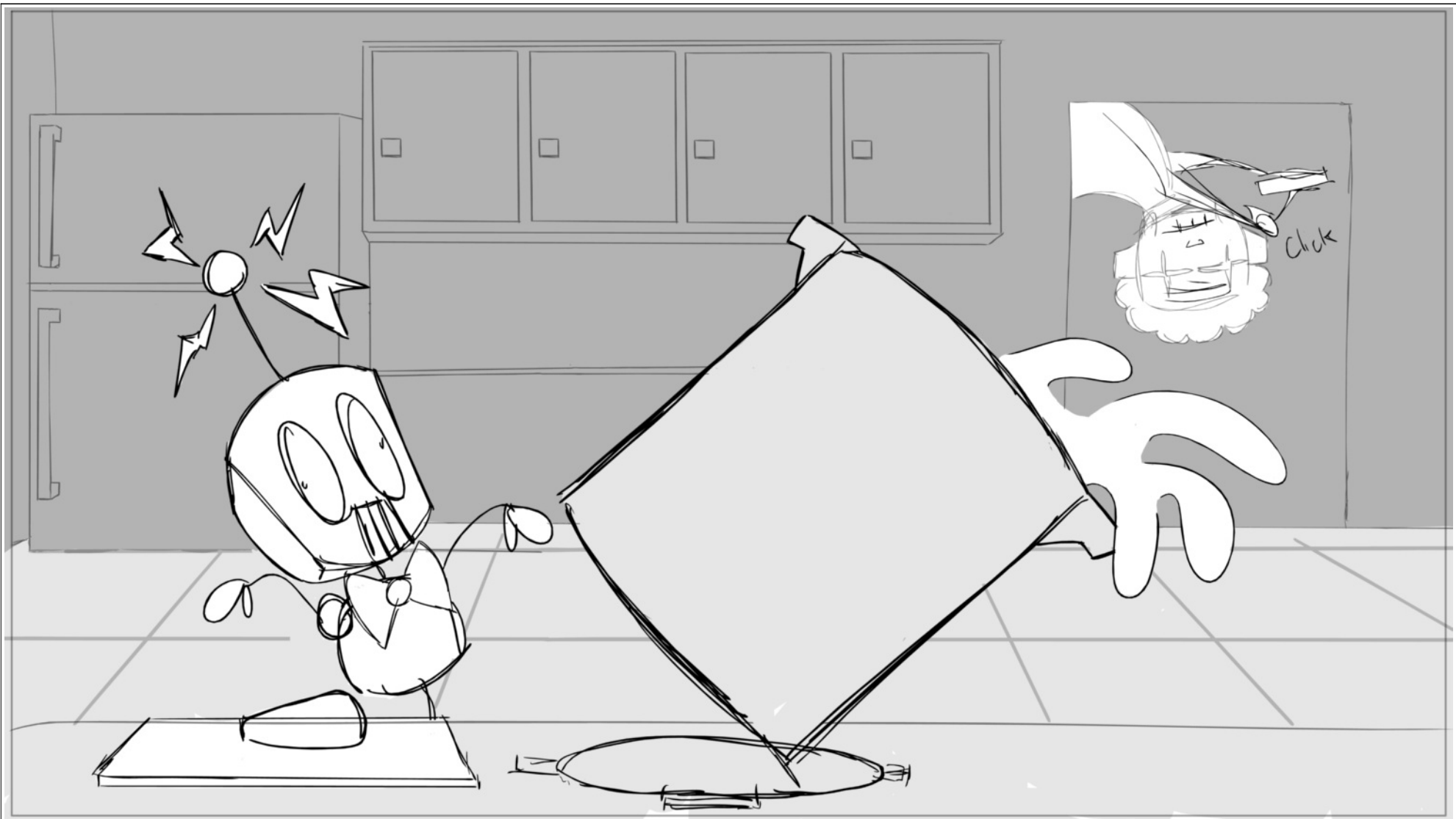

Scene	Duration	Panel	Duration
1_A_1_A	02:22:18	37	02:00

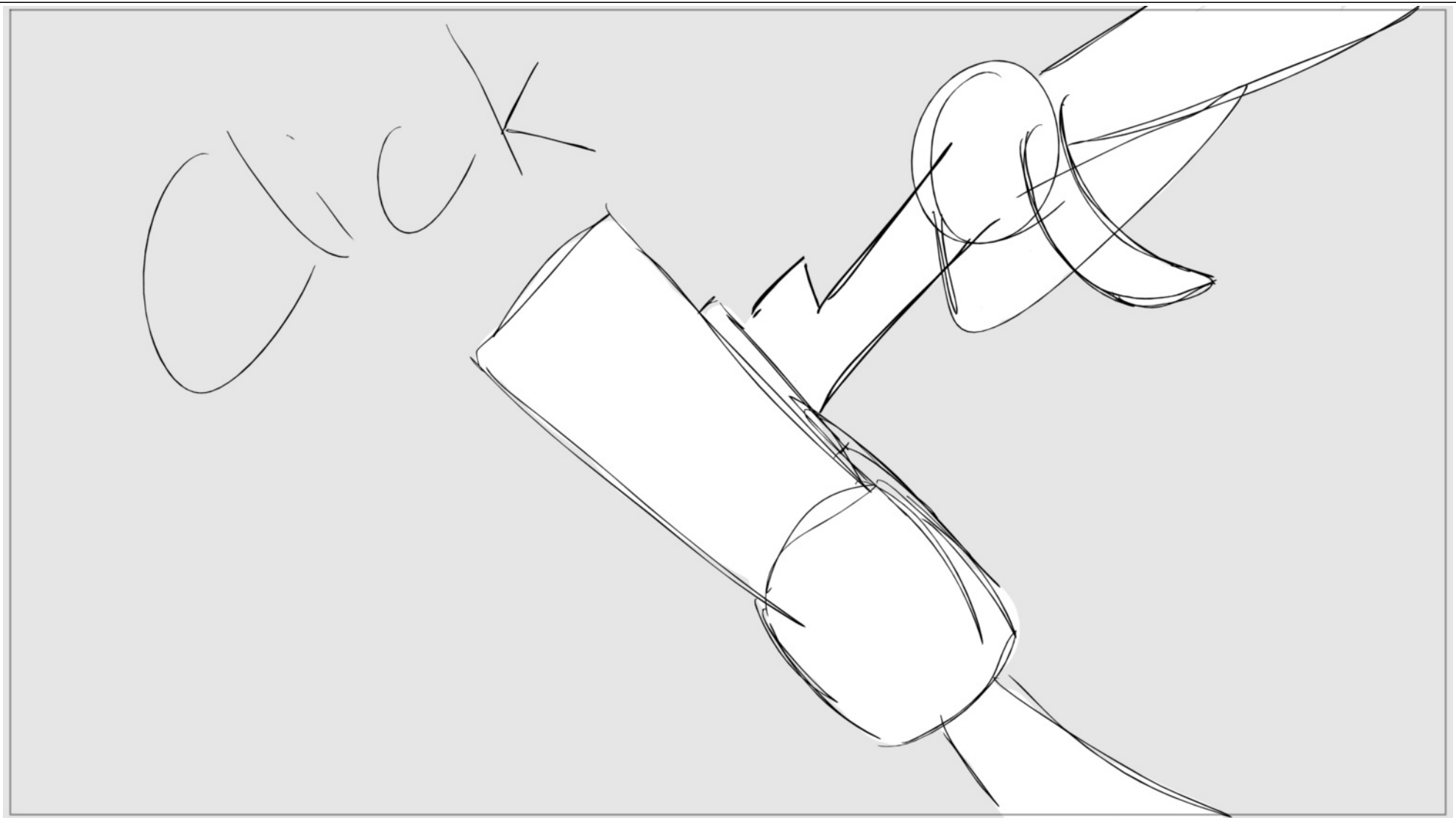

Scene	Duration	Panel	Duration
1_A_1_A	02:22:18	38	01:00

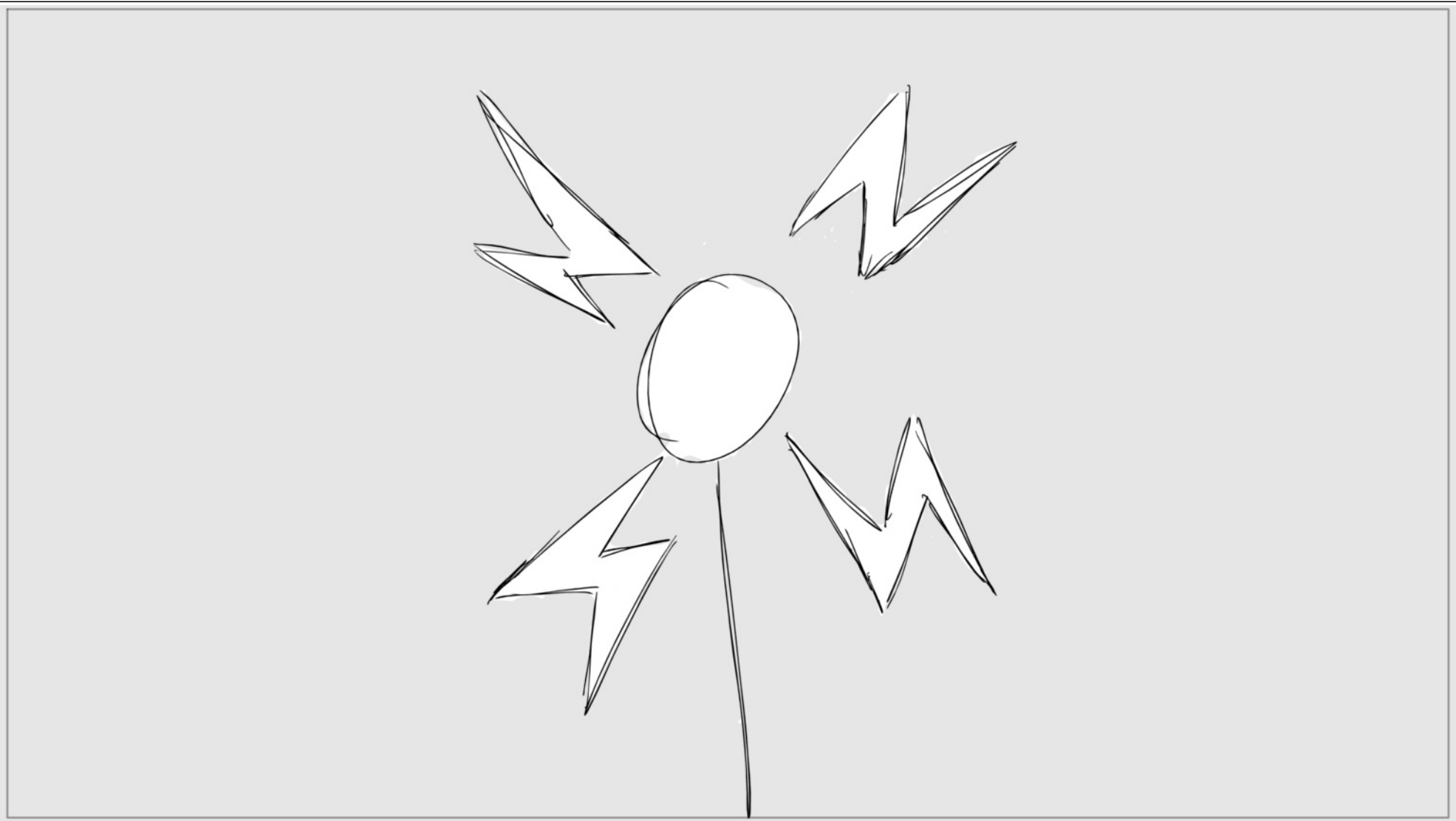

Scene	Duration	Panel	Duration
1_A_1_A	02:22:18	39	02:00

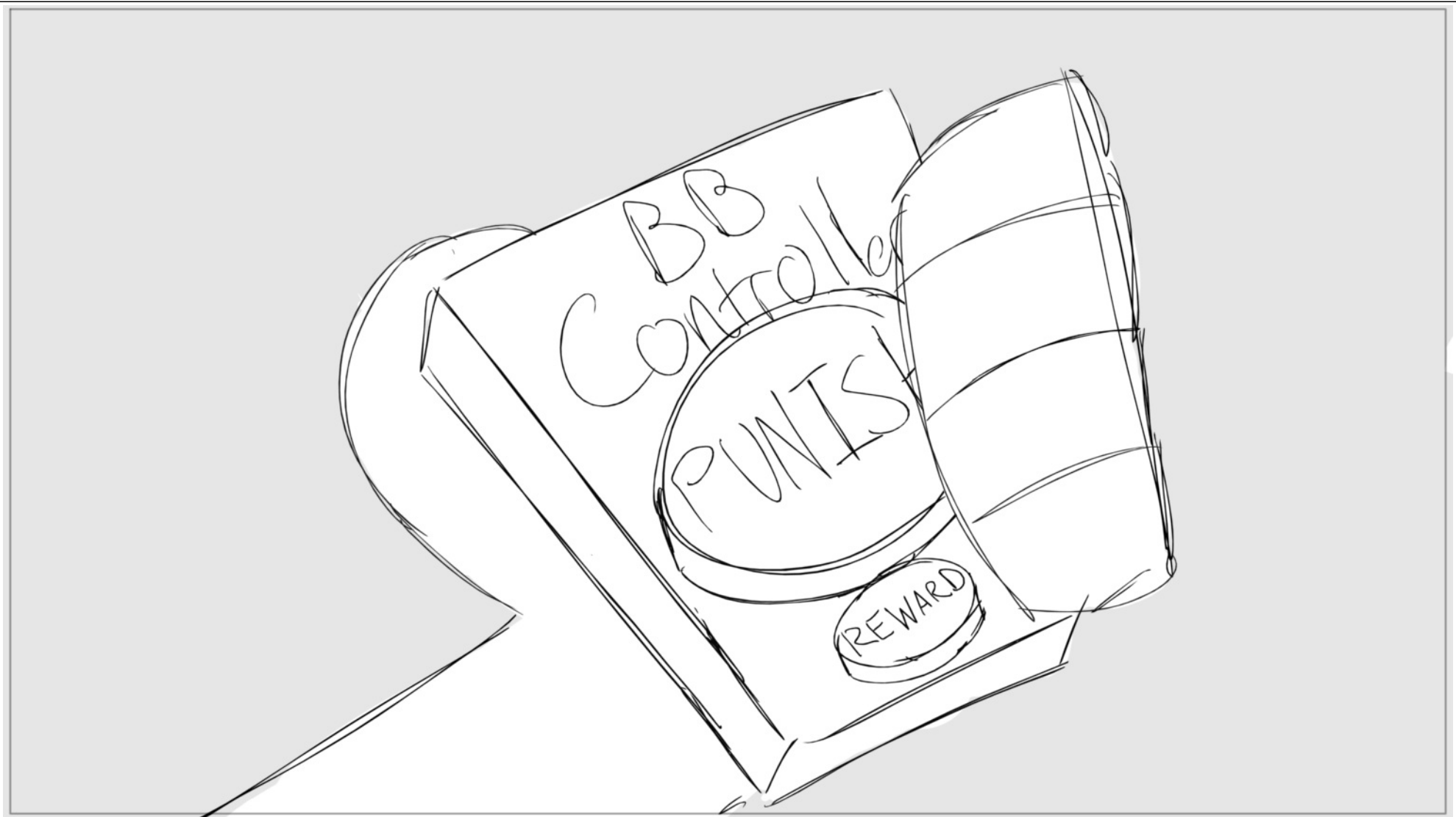

Scene	Duration	Panel	Duration
1_A_1_A	02:22:18	40	01:00

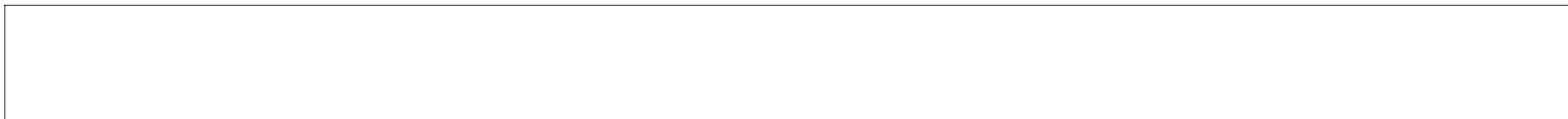
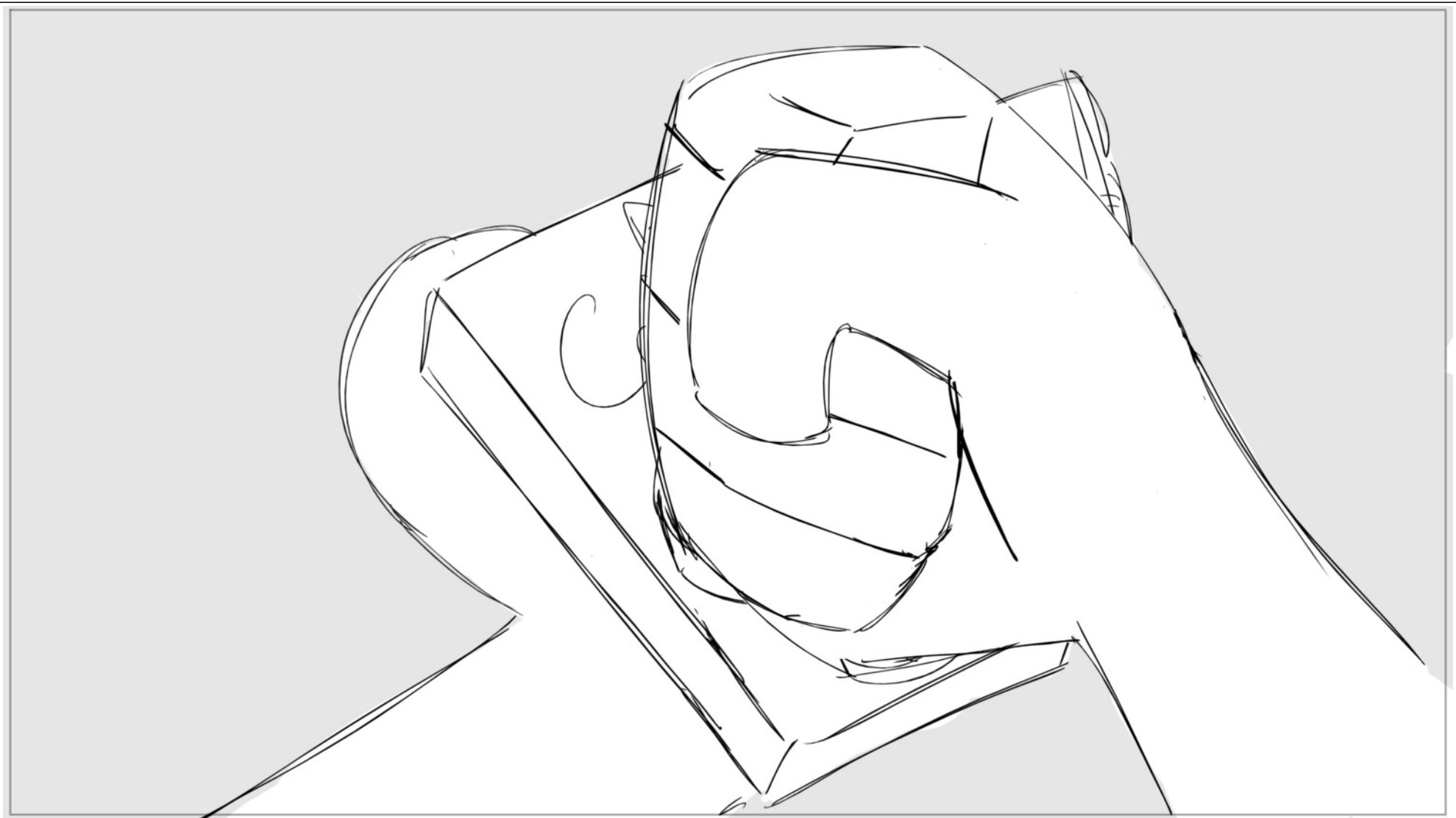

Scene	Duration	Panel	Duration
1_A_1_A	02:22:18	41	01:00

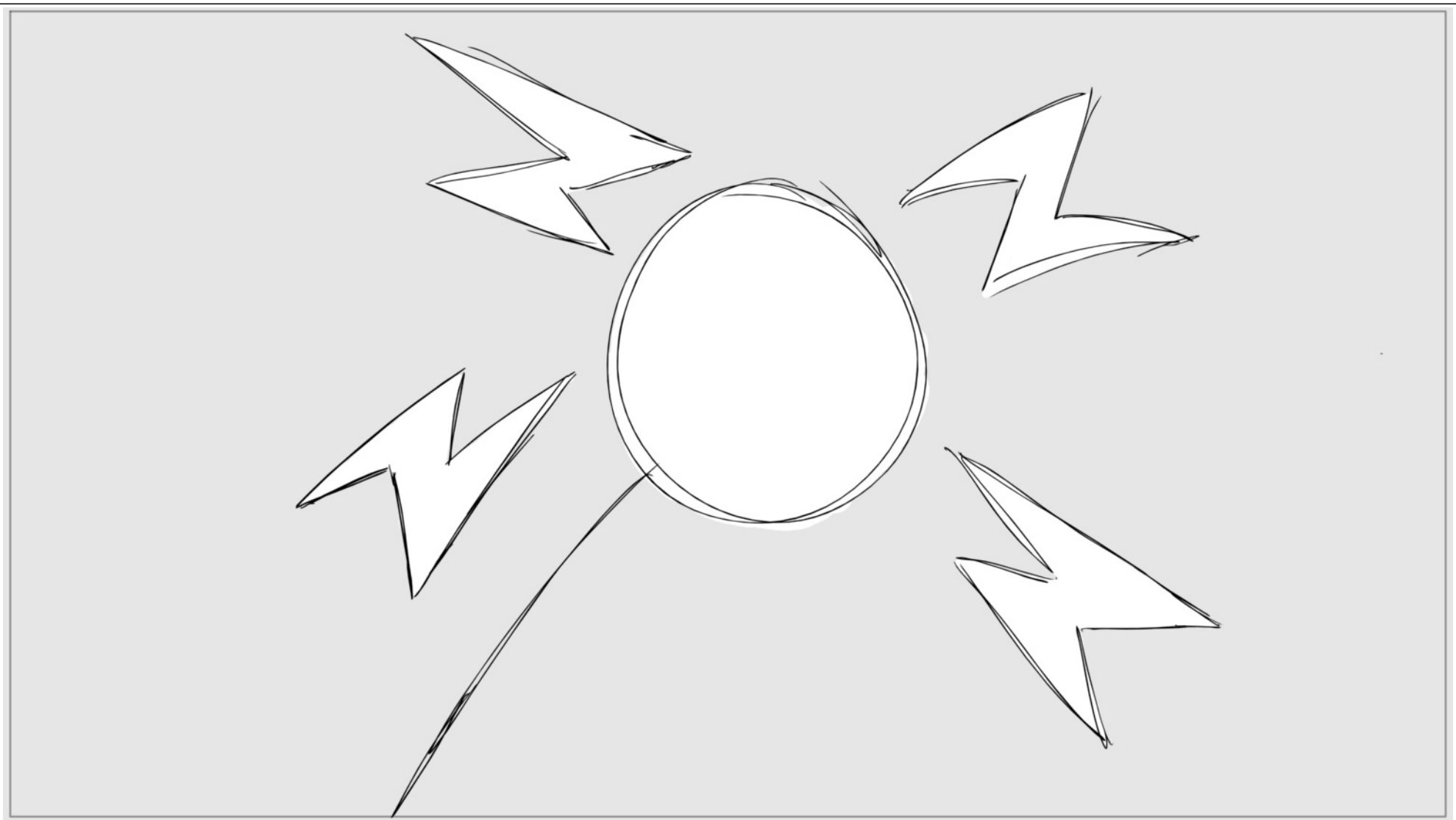

Scene	Duration	Panel	Duration
1_A_1_A	02:22:18	42	03:00



Scene	Duration	Panel	Duration
1_A_1_A	02:22:18	43	03:00

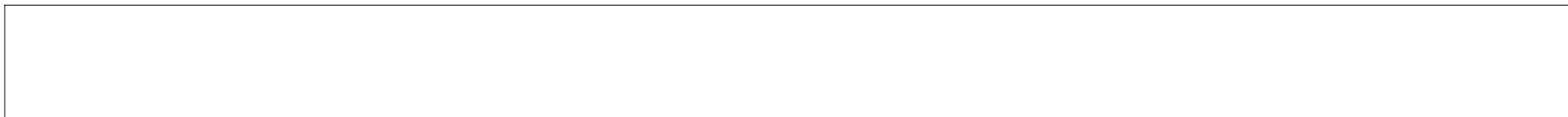
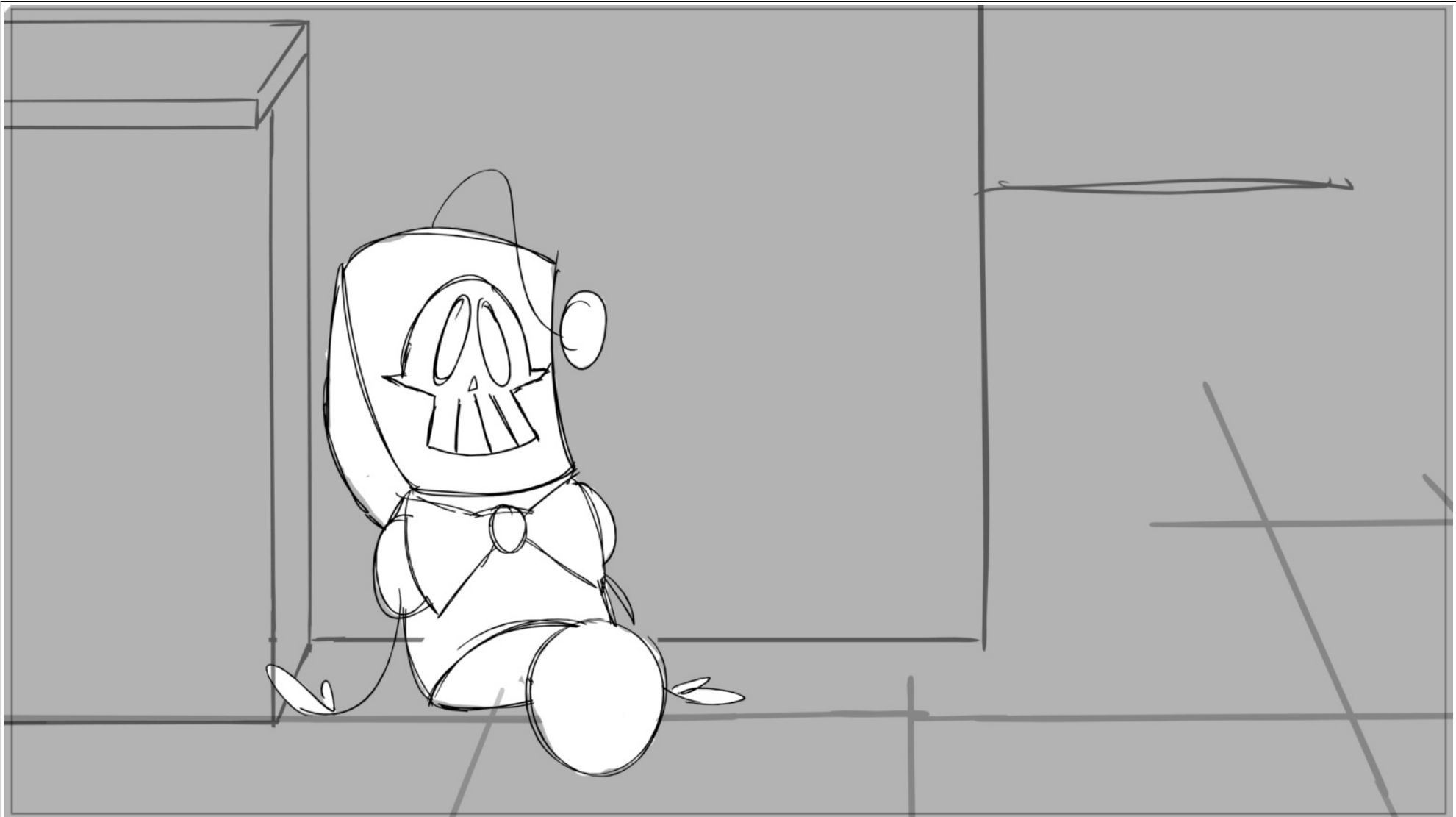

Scene	Duration	Panel	Duration
1_A_1_A	02:22:18	44	01:00

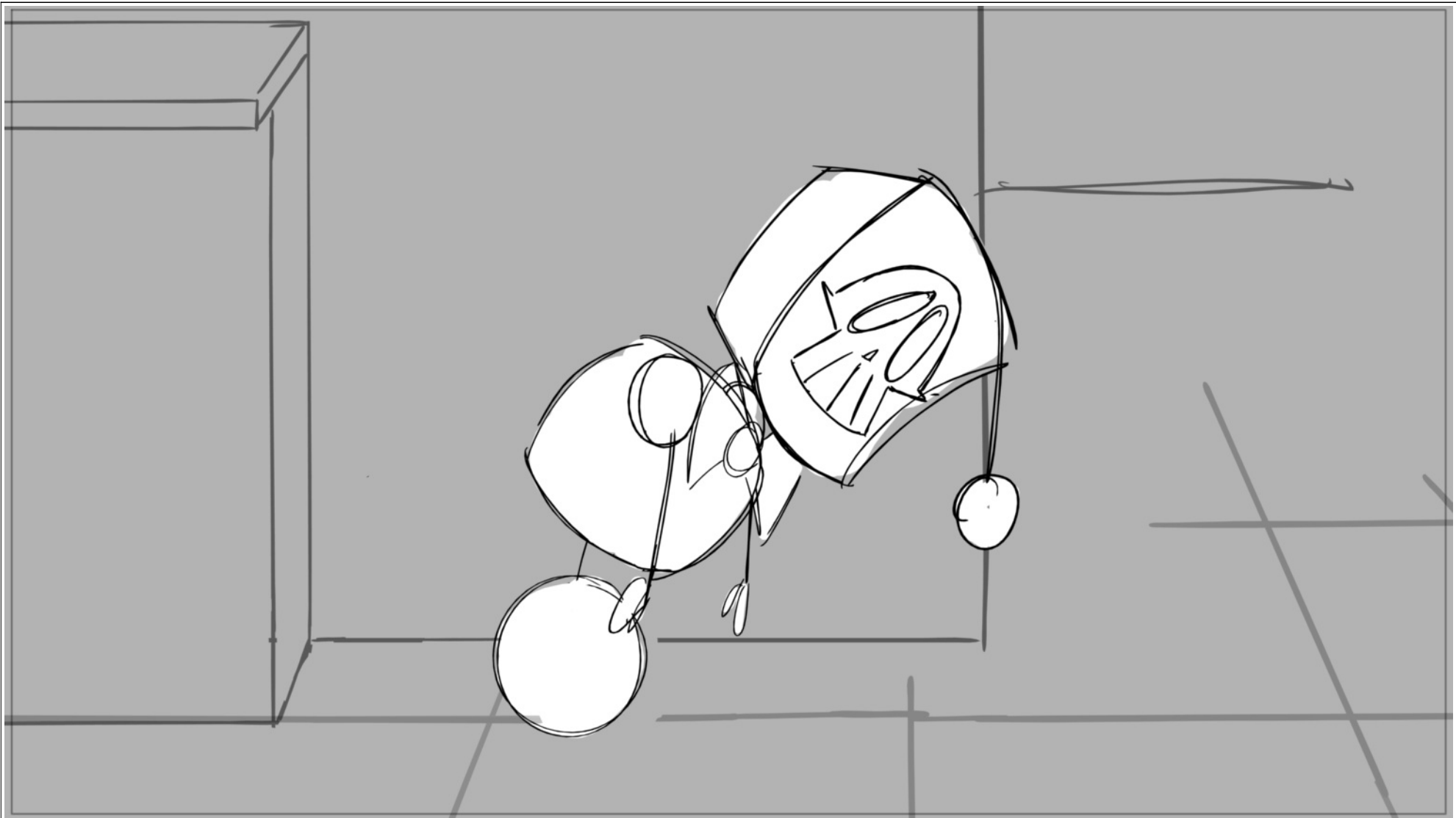

Scene	Duration	Panel	Duration
1_A_1_A	02:22:18	45	02:00

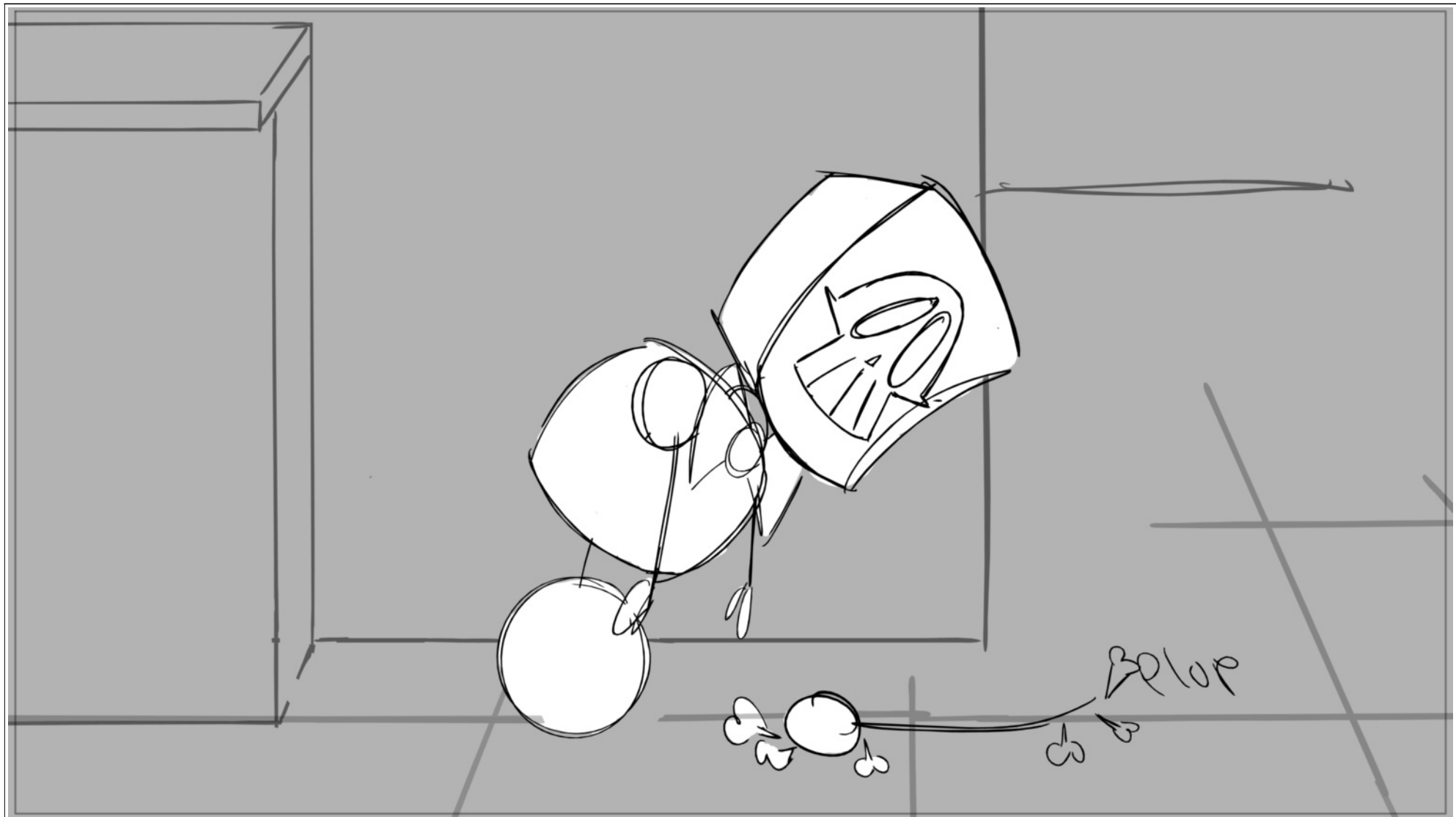

Scene	Duration	Panel	Duration
1_A_1_A	02:22:18	46	01:00

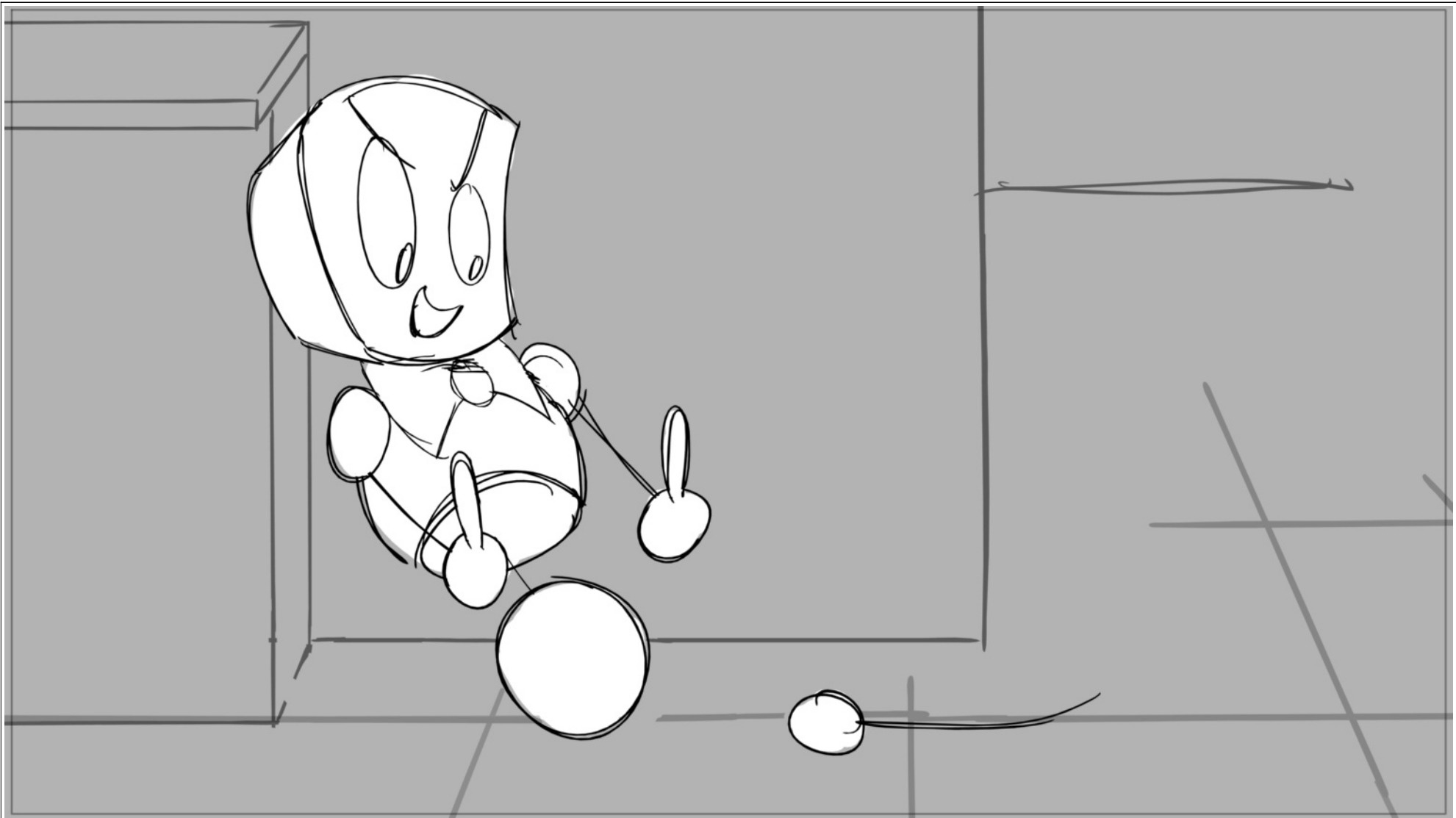

Scene	Duration	Panel	Duration
1_A_1_A	02:22:18	47	01:00

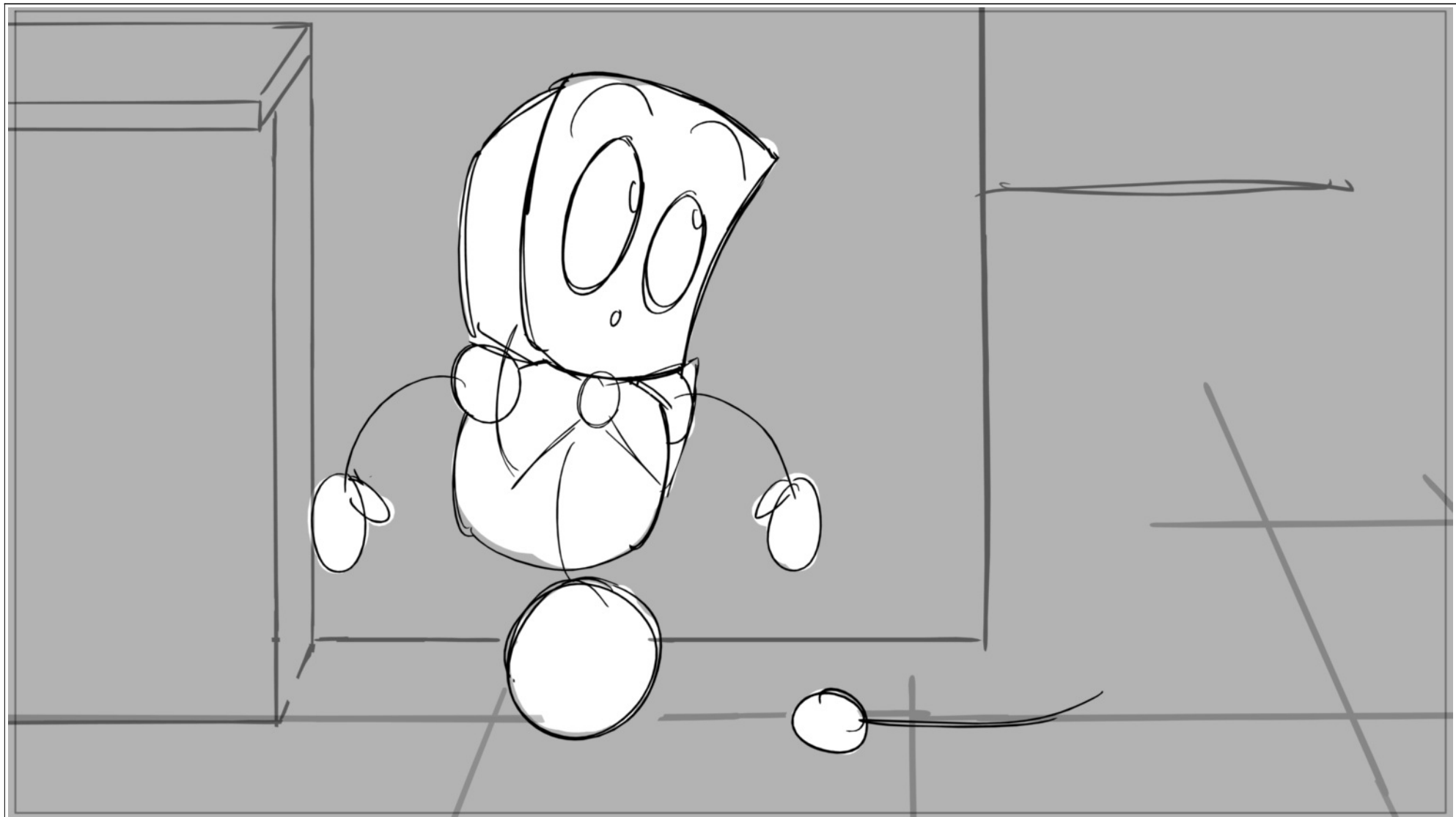

Scene	Duration	Panel	Duration
1_A_1_A	02:22:18	48	02:12

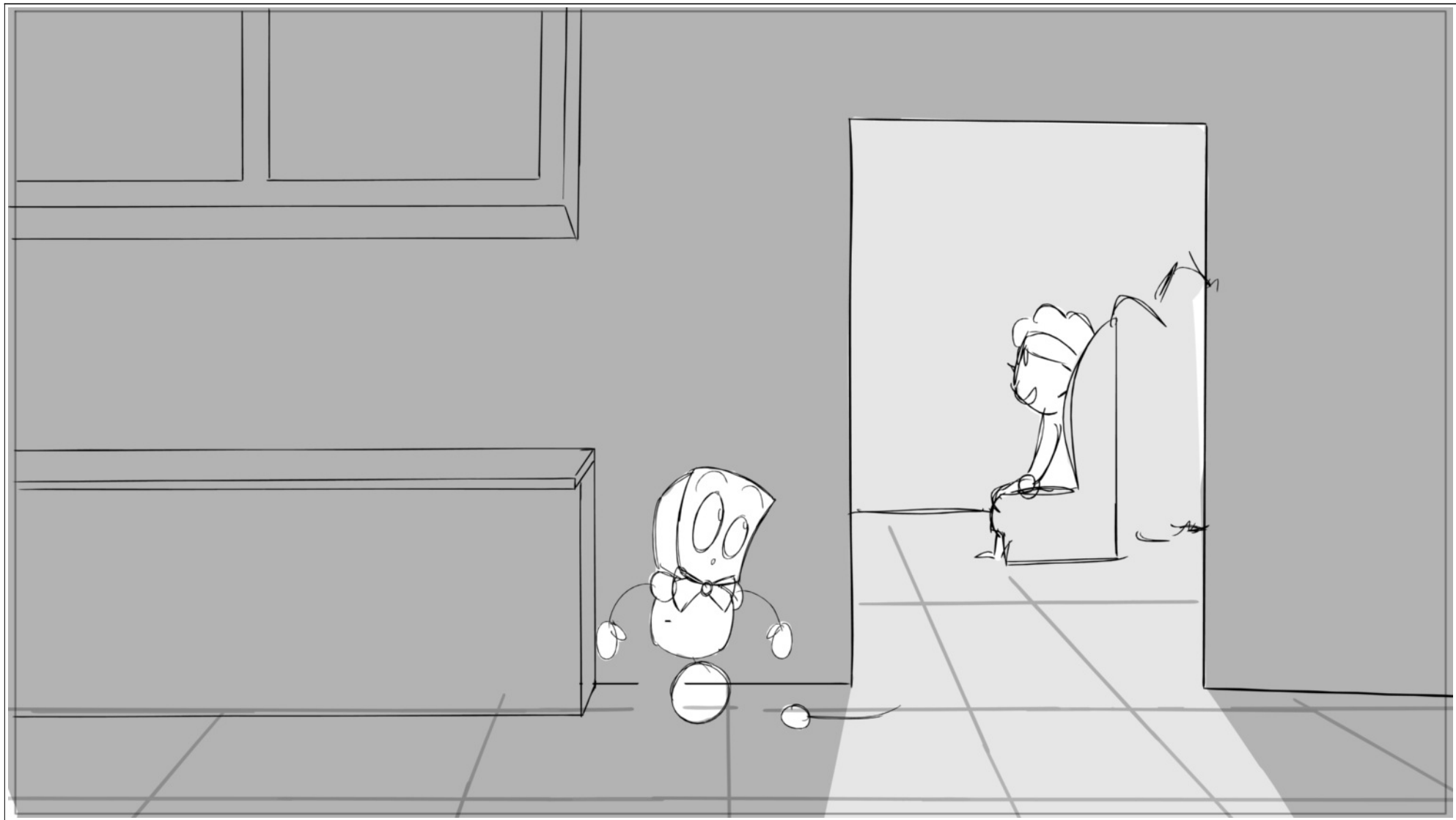

Scene	Duration	Panel	Duration
1_A_1_A	02:22:18	49	02:00



Scene	Duration	Panel	Duration
1_A_1_A	02:22:18	50	01:00

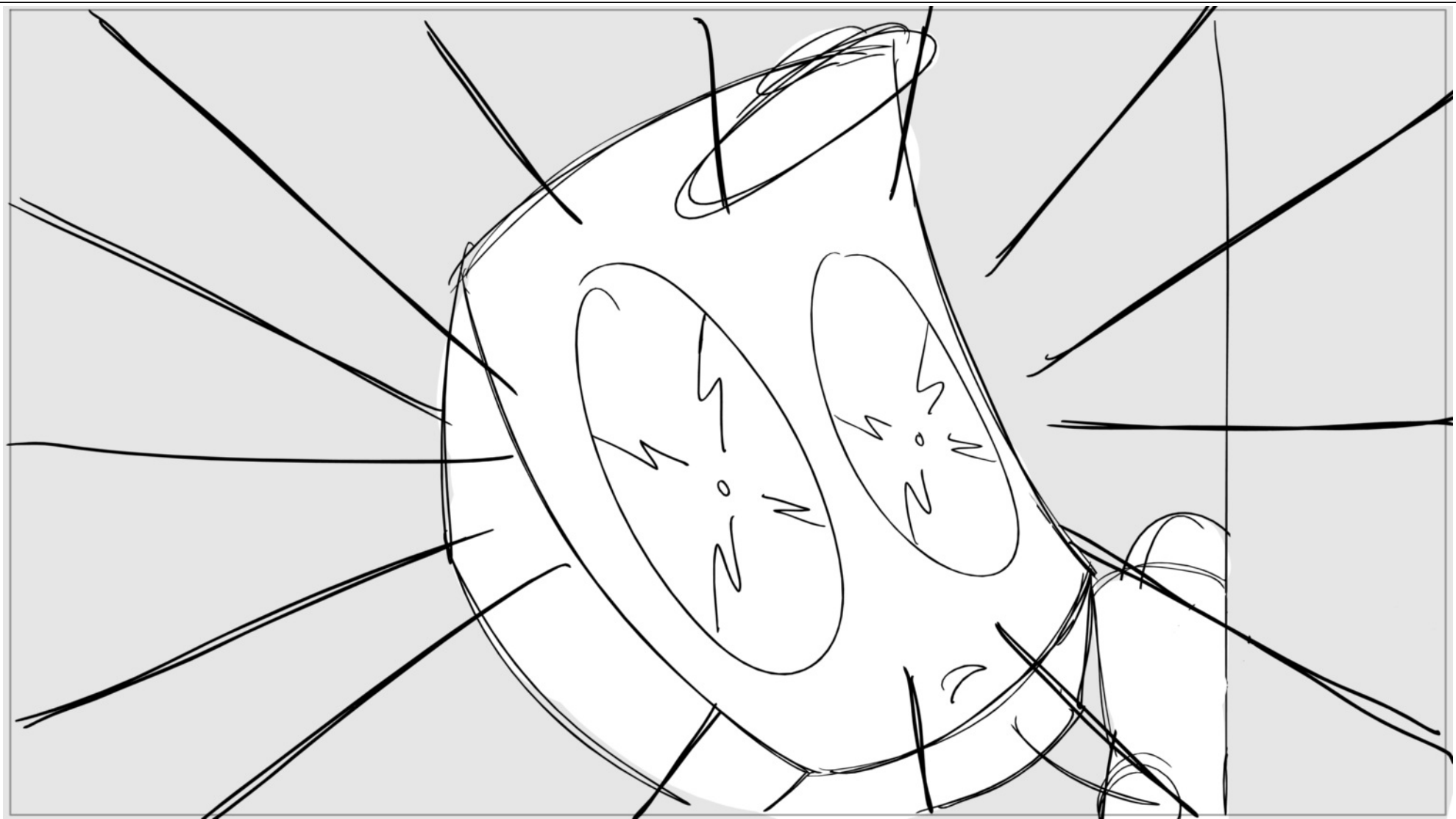

Scene	Duration	Panel	Duration
1_A_1_A	02:22:18	51	02:00



Scene	Duration	Panel	Duration
1_A_1_A	02:22:18	52	01:00

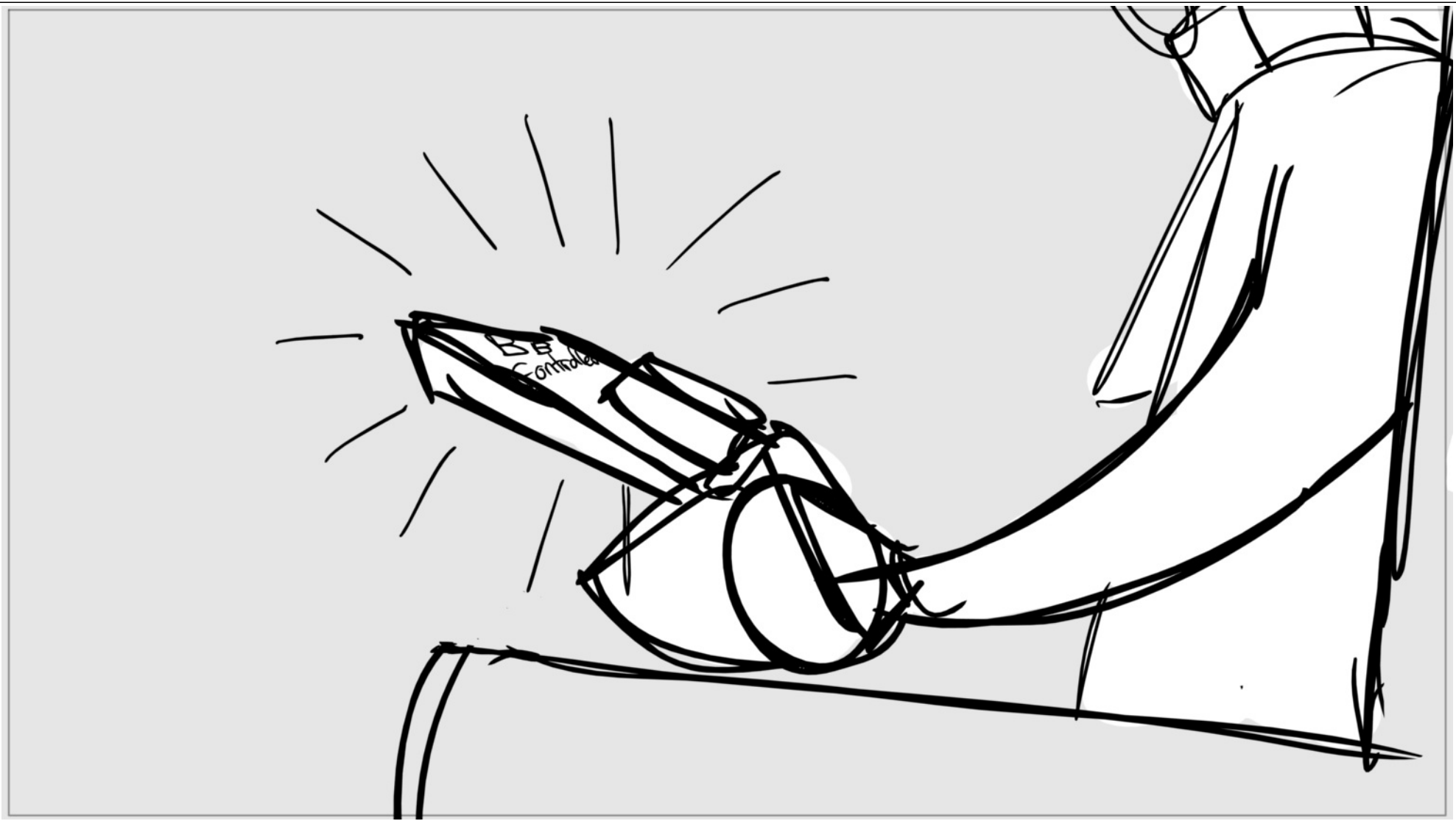

Scene	Duration	Panel	Duration
1_A_1_A	02:22:18	53	02:00

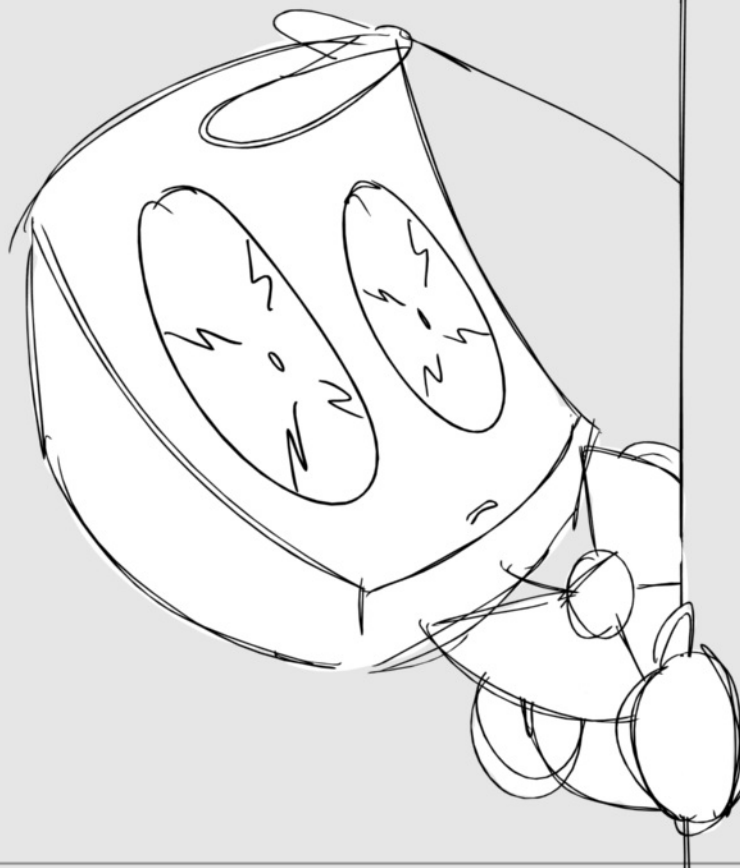

Scene	Duration	Panel	Duration
1_A_1_A	02:22:18	54	02:00

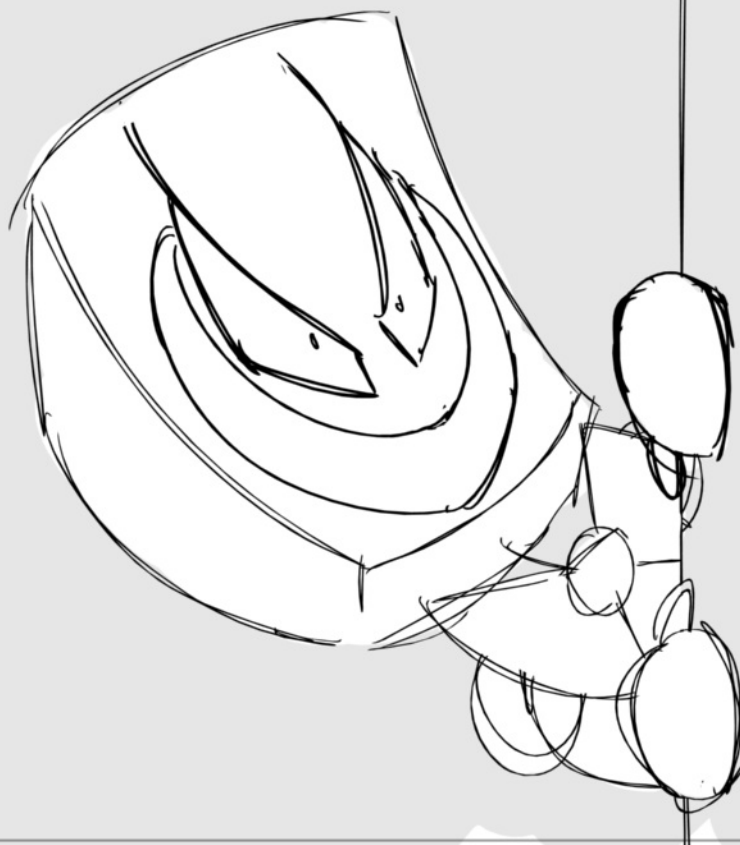

Scene	Duration	Panel	Duration
1_A_1_A	02:22:18	55	03:00



Scene	Duration	Panel	Duration
1_A_1_A	02:22:18	56	01:00

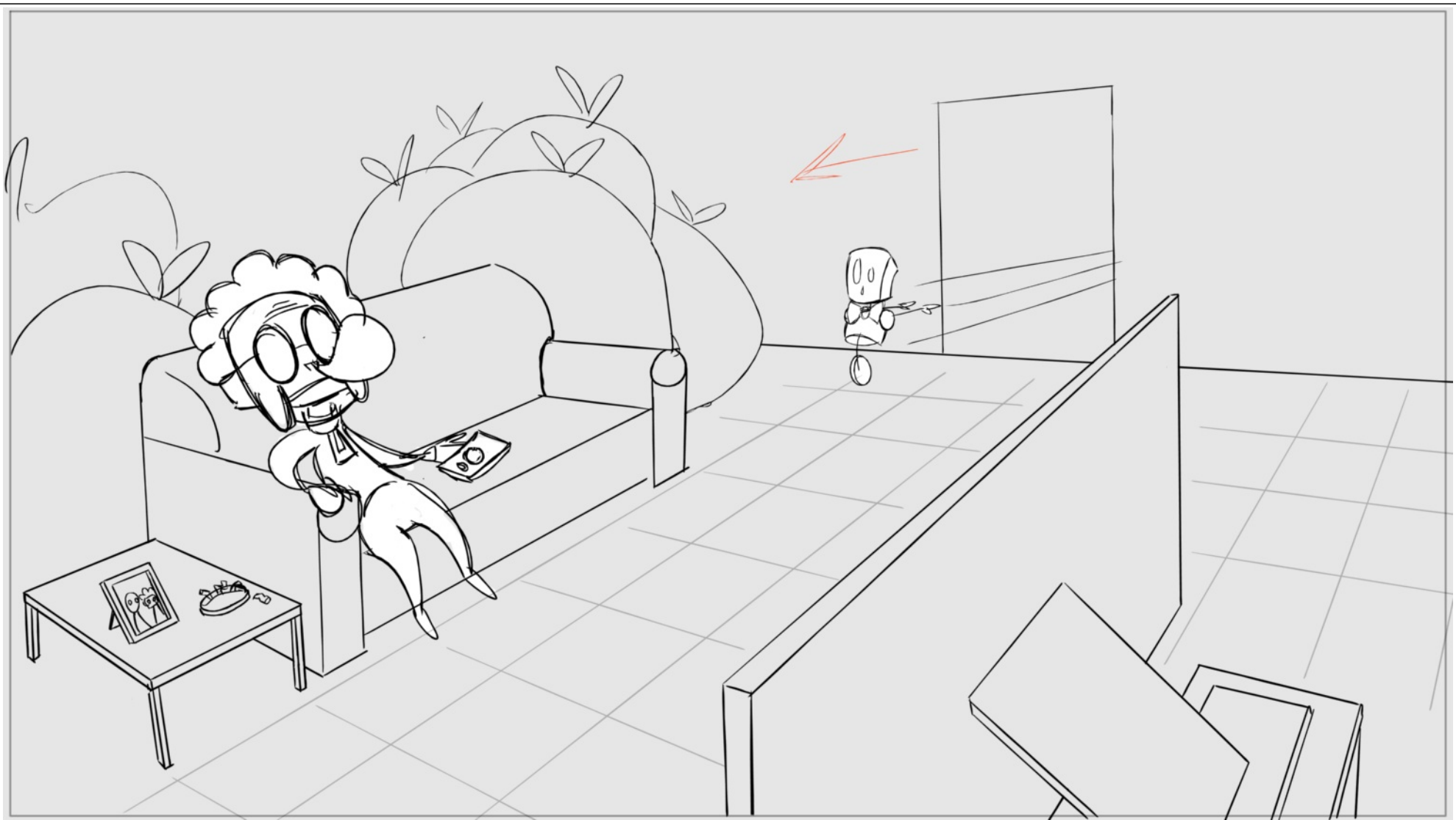

Scene	Duration	Panel	Duration
1_A_1_A	02:22:18	57	02:12



Scene	Duration	Panel	Duration
1_A_1_A	02:22:18	58	02:12

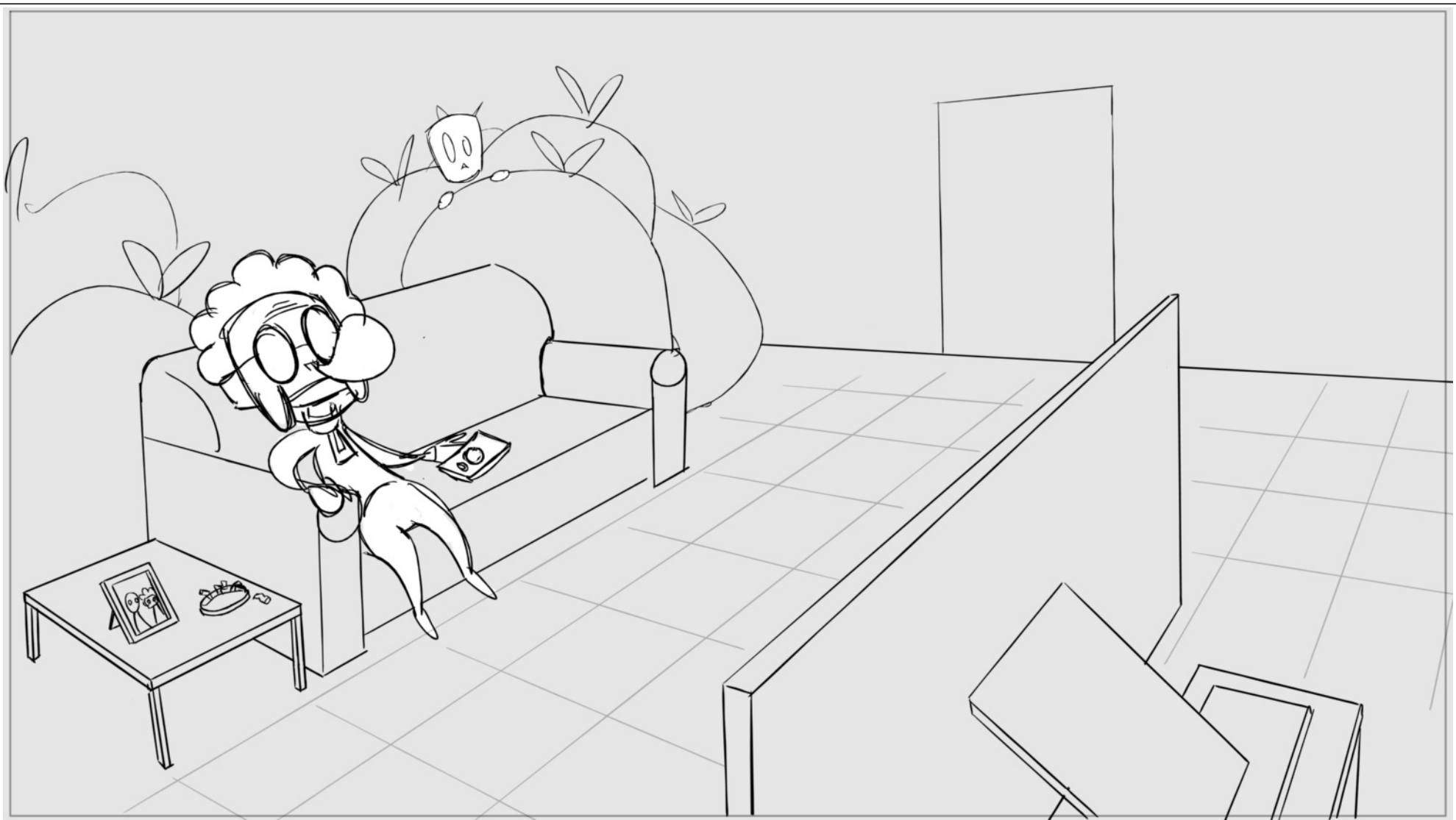

Scene	Duration	Panel	Duration
1_A_1_A	02:22:18	59	02:00



Scene	Duration	Panel	Duration
1_A_1_A	02:22:18	60	02:12

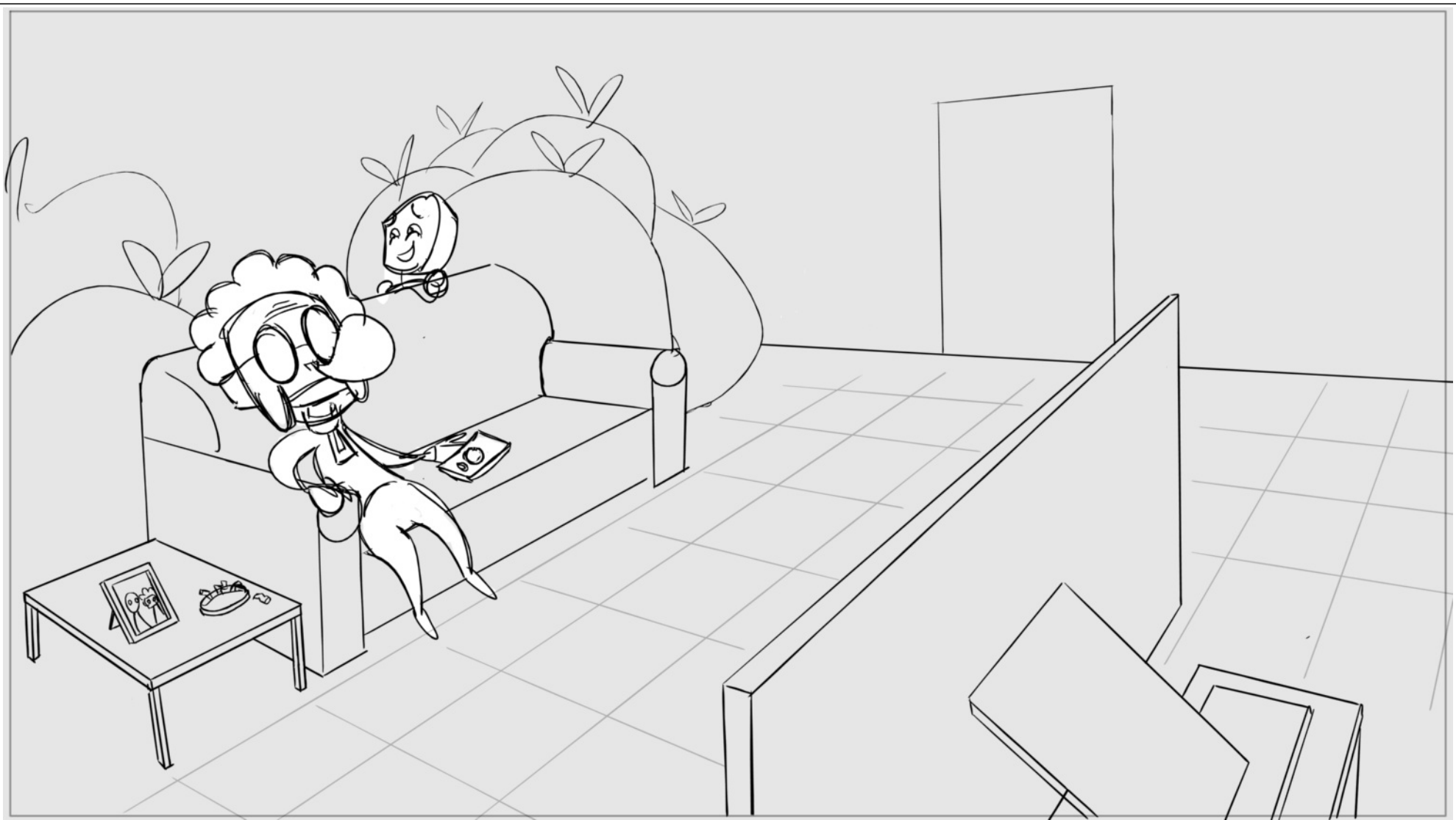

Scene	Duration	Panel	Duration
1_A_1_A	02:22:18	61	03:00

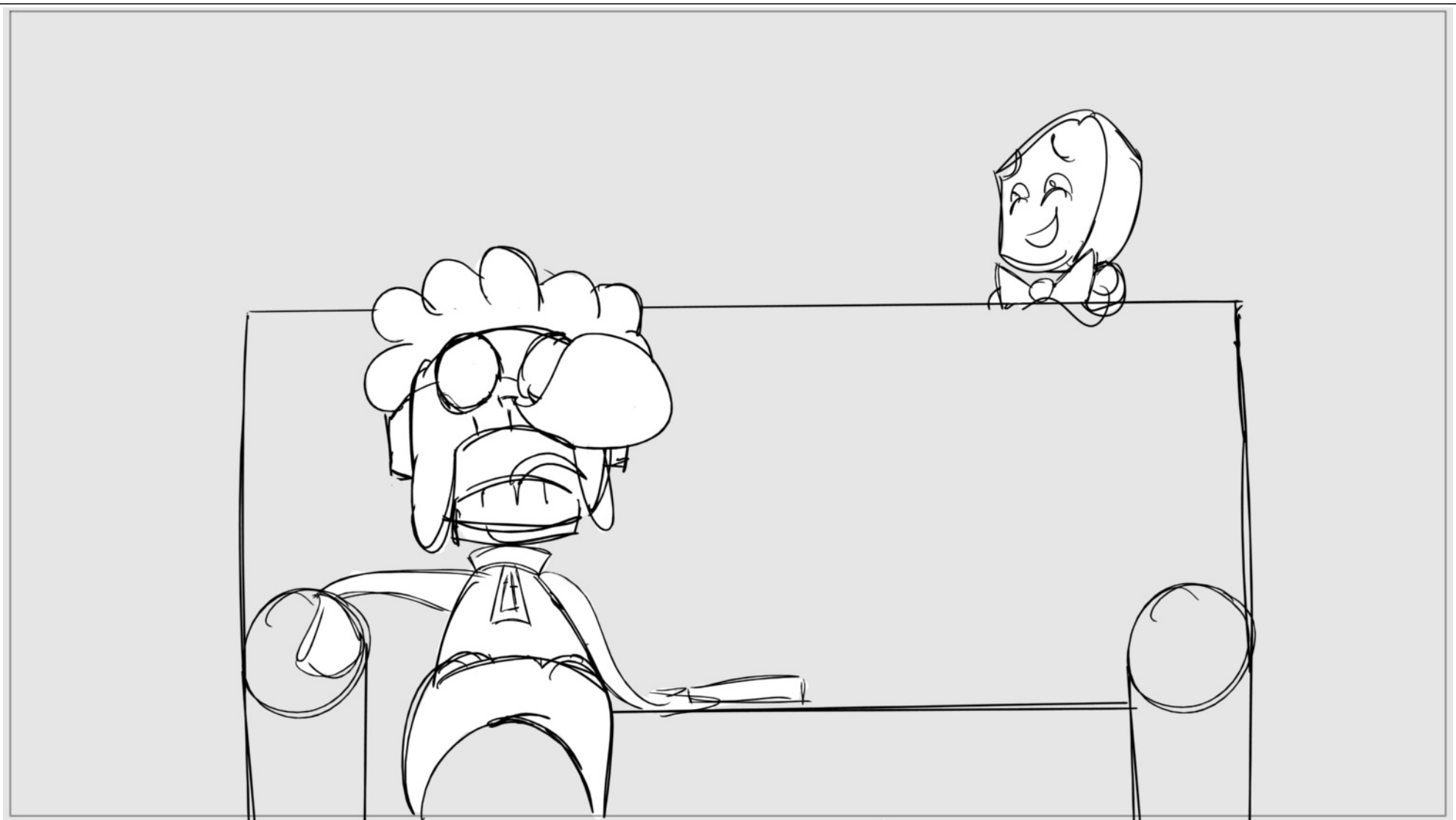

Scene	Duration	Panel	Duration
1_A_1_A	02:22:18	62	02:00



Scene	Duration	Panel	Duration
1_A_1_A	02:22:18	63	01:12

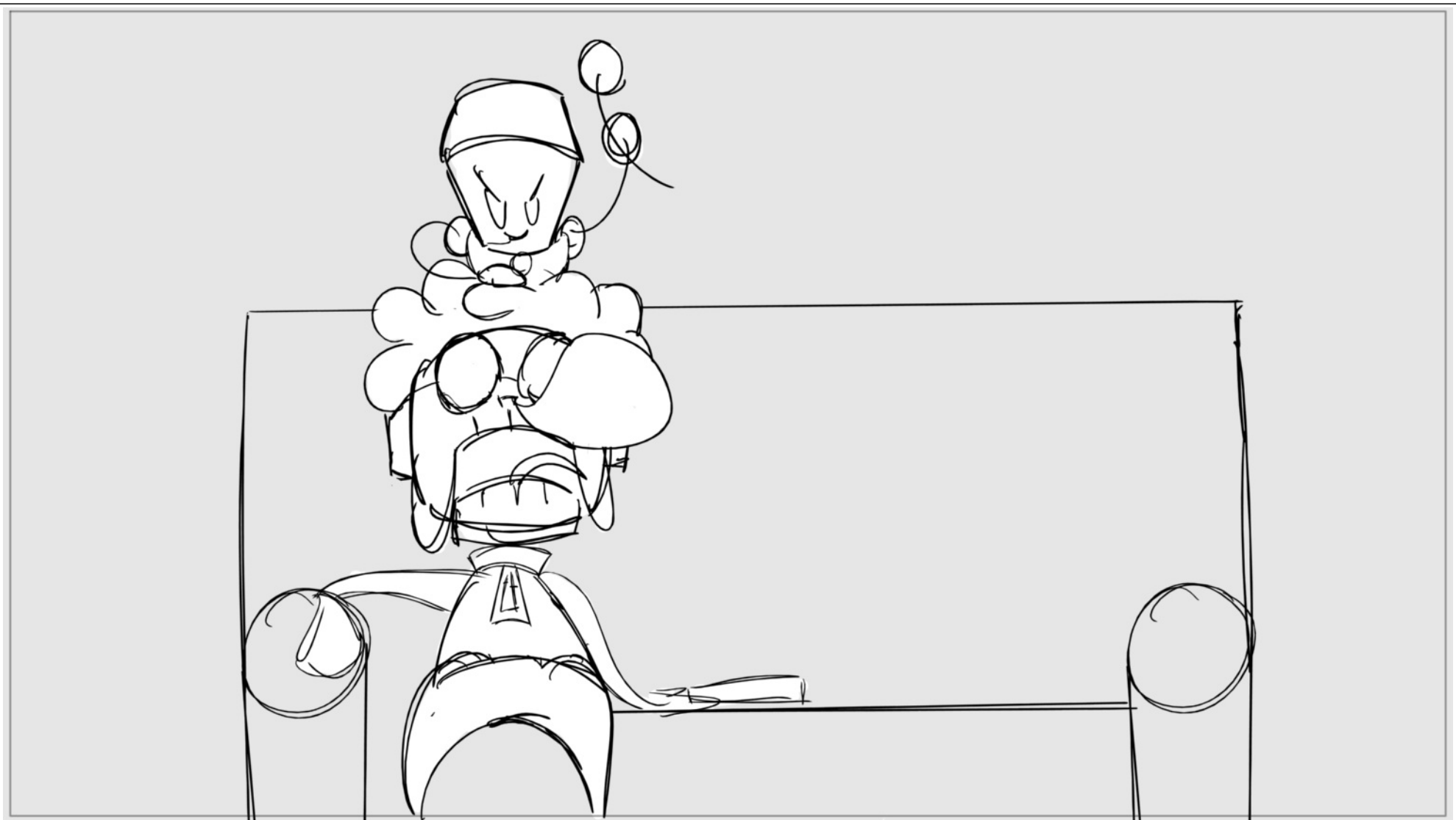

Scene	Duration	Panel	Duration
1_A_1_A	02:22:18	64	02:00



Scene	Duration	Panel	Duration
1_A_1_A	02:22:18	65	02:12



Scene	Duration	Panel	Duration
1_A_1_A	02:22:18	66	02:00



Scene	Duration	Panel	Duration
1_A_1_A	02:22:18	67	00:12



Scene	Duration	Panel	Duration
1_A_1_A	02:22:18	68	02:00



Scene	Duration	Panel	Duration
1_A_1_A	02:22:18	69	02:00



Scene	Duration	Panel	Duration
1_A_1_A	02:22:18	70	02:00



Scene	Duration	Panel	Duration
1_A_1_A	02:22:18	71	01:00



Scene	Duration	Panel	Duration
1_A_1_A	02:22:18	72	01:00



Scene	Duration	Panel	Duration
1_A_1_A	02:22:18	73	02:00



Scene	Duration	Panel	Duration
1_A_1_A	02:22:18	74	02:00

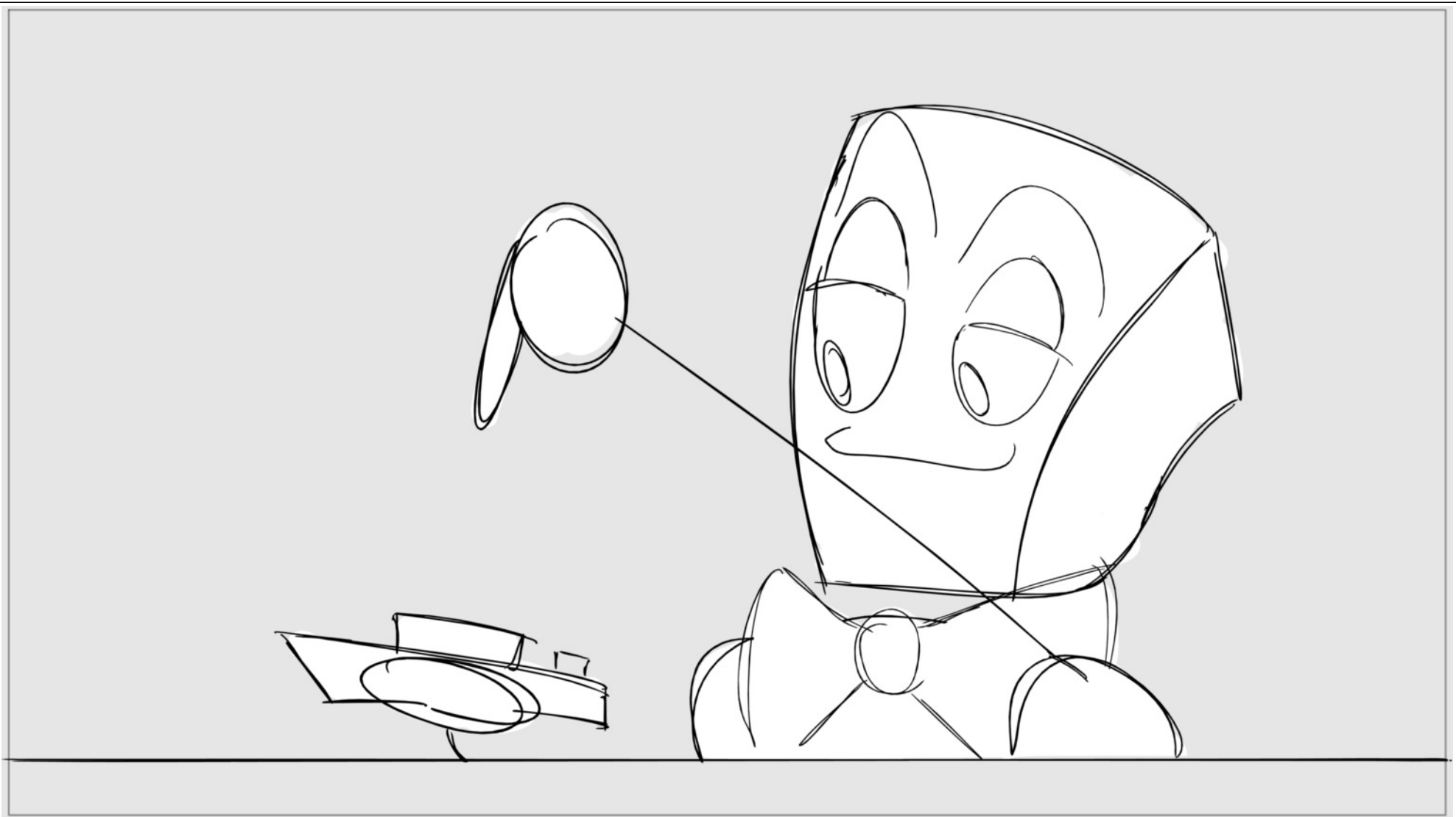

Scene	Duration	Panel	Duration
1_A_1_A	02:22:18	75	01:00

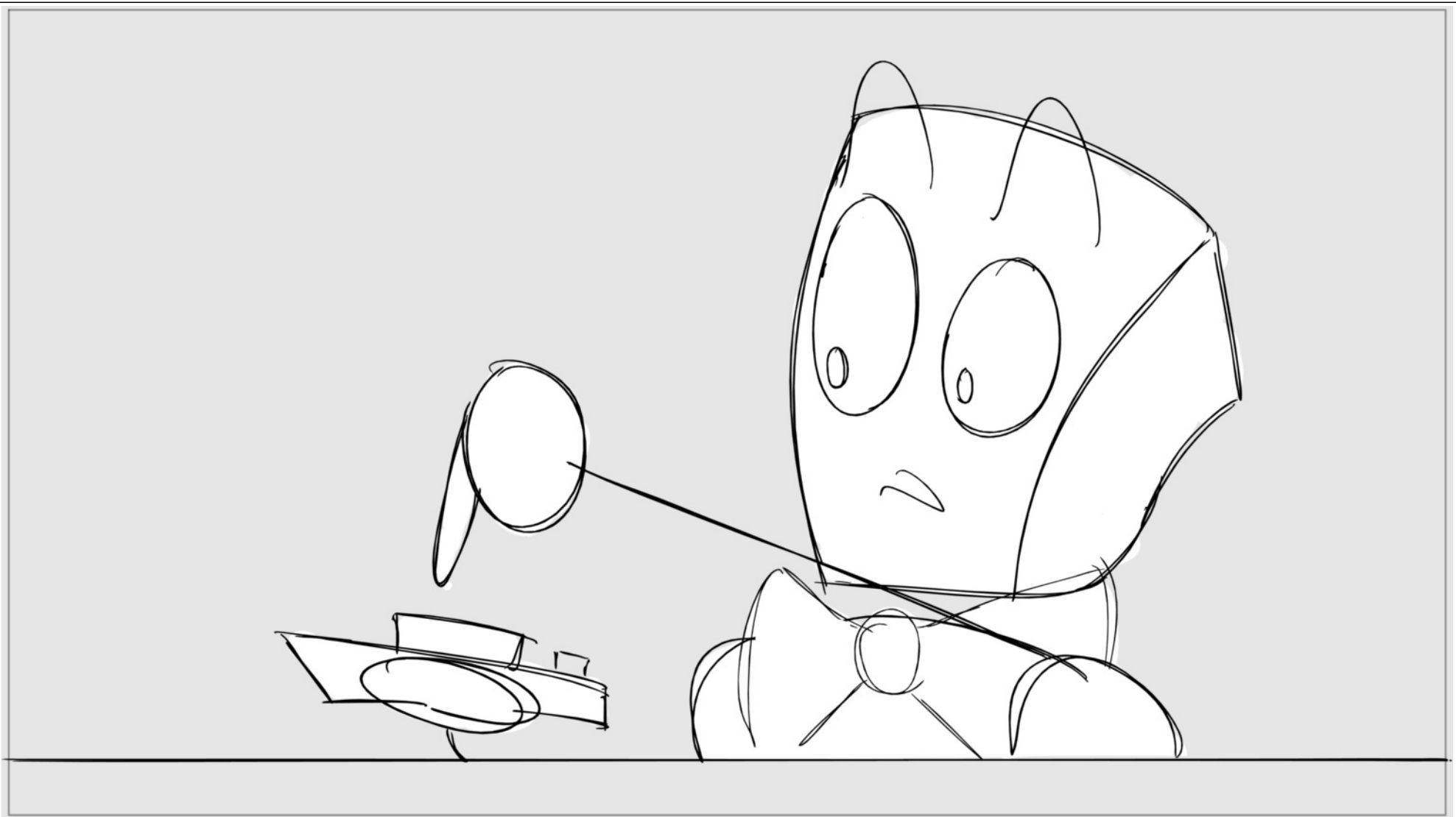

Scene	Duration	Panel	Duration
1_A_1_A	02:22:18	76	03:00

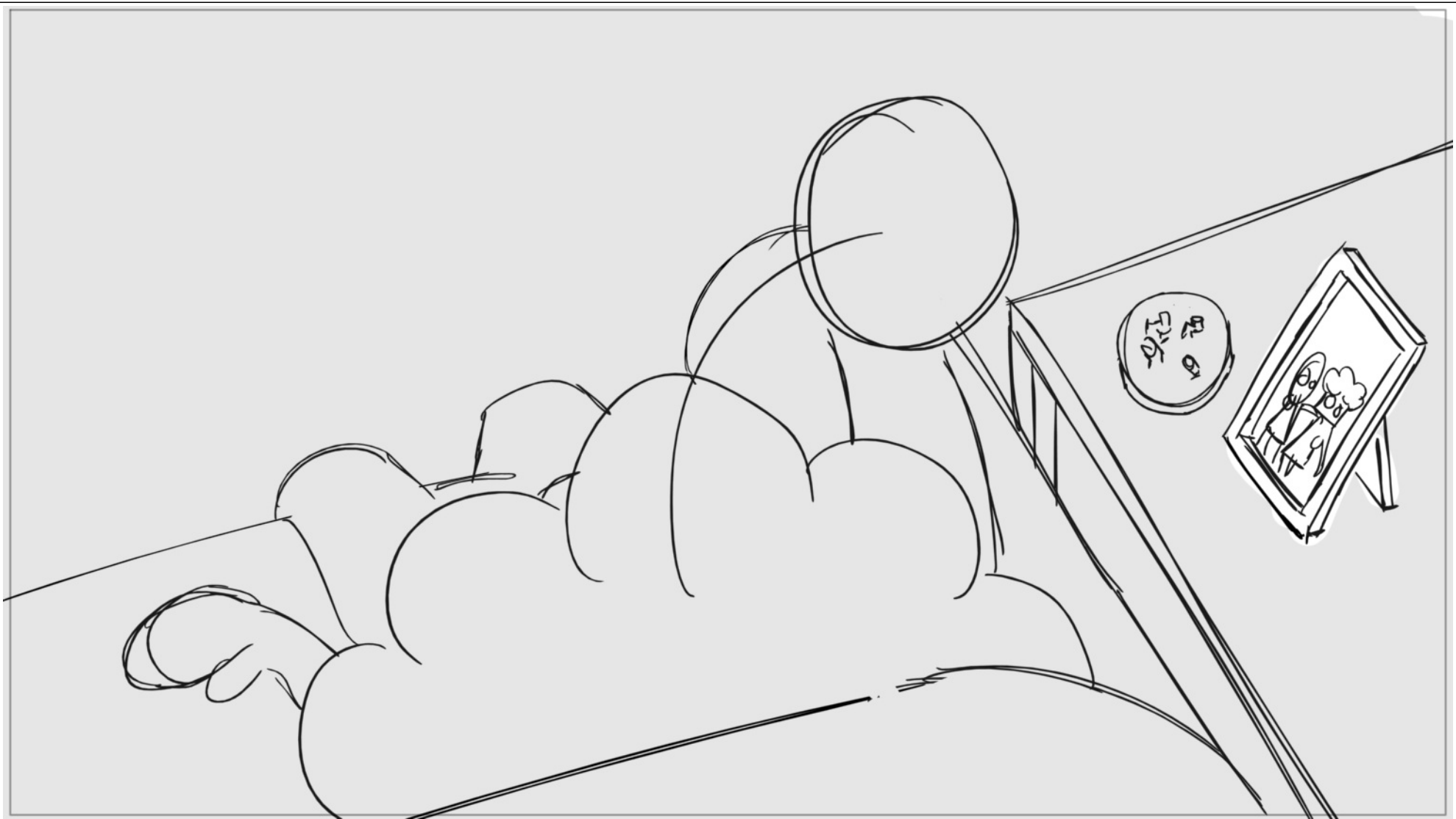

Scene	Duration	Panel	Duration
1_A_1_A	02:22:18	77	03:00

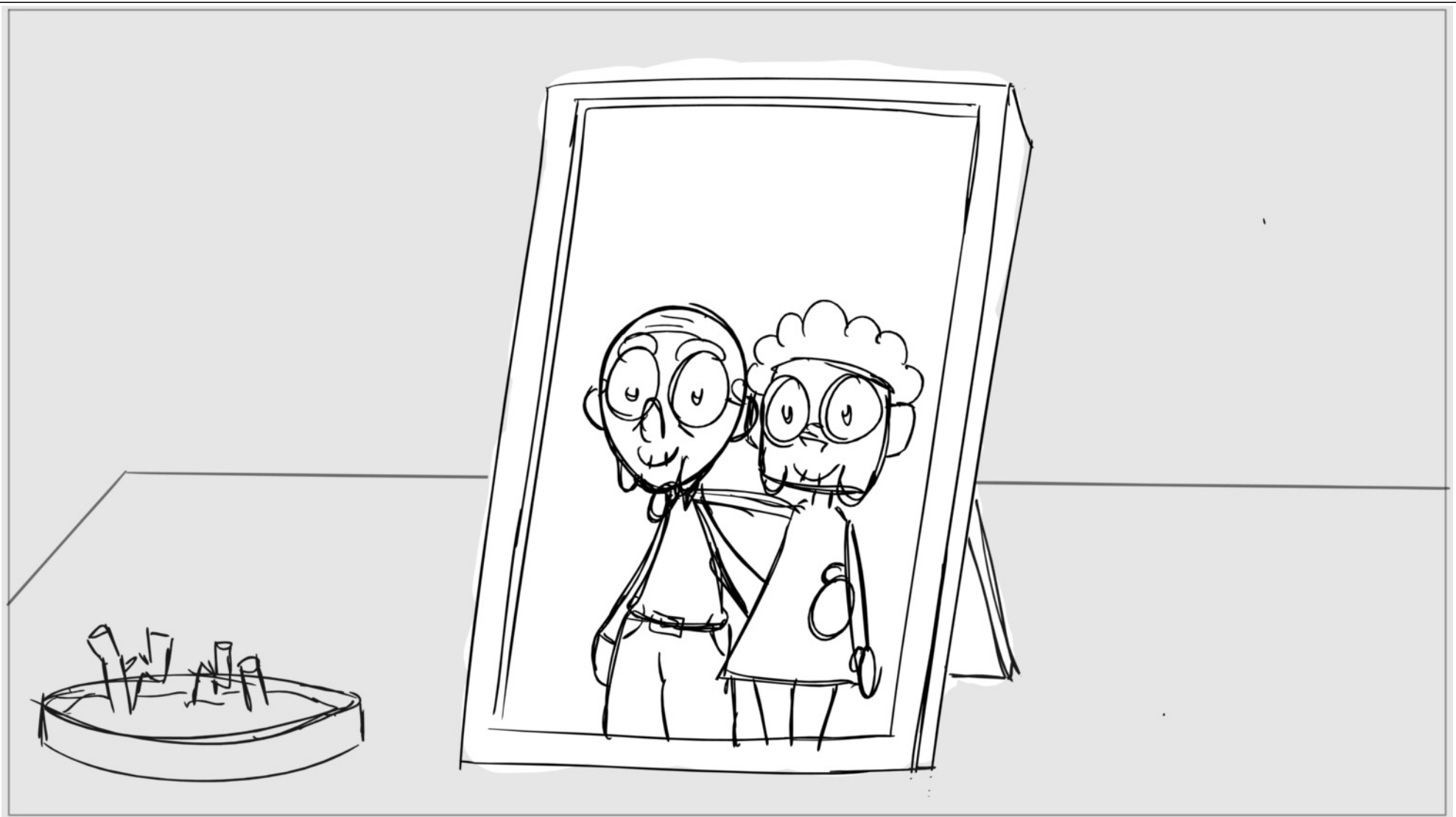

Scene	Duration	Panel	Duration
1_A_1_A	02:22:18	78	02:00

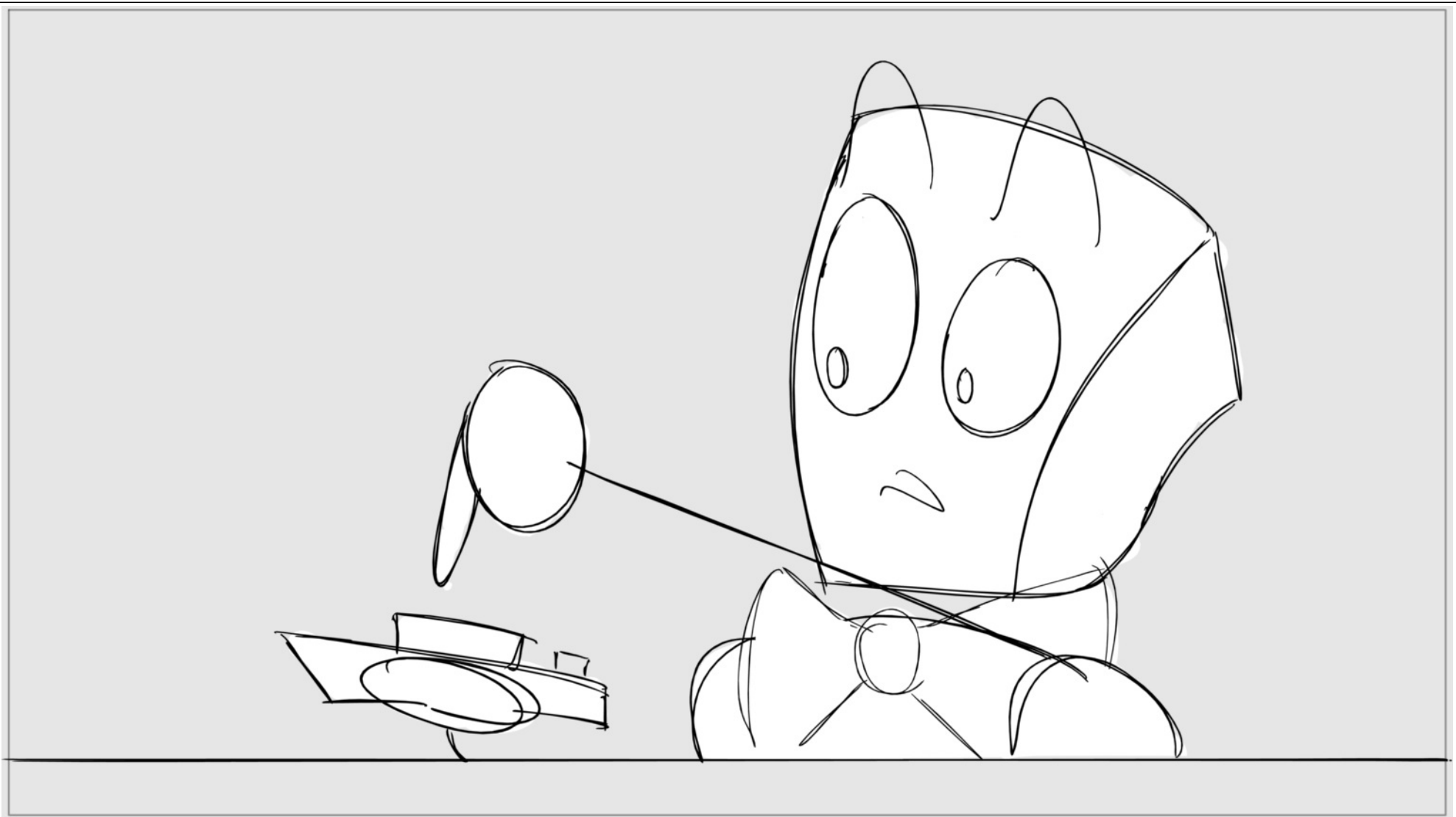

Scene	Duration	Panel	Duration
1_A_1_A	02:22:18	79	01:00

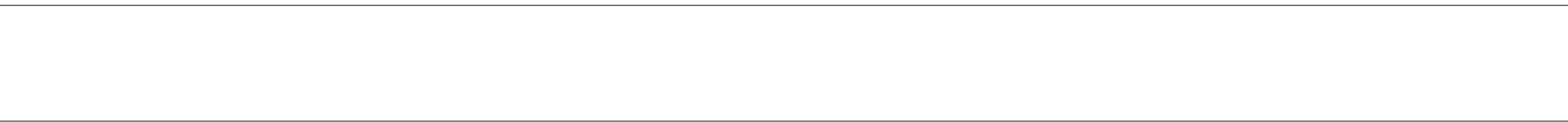

Scene	Duration	Panel	Duration
1_A_1_A_1_0	05:00	1	05:00

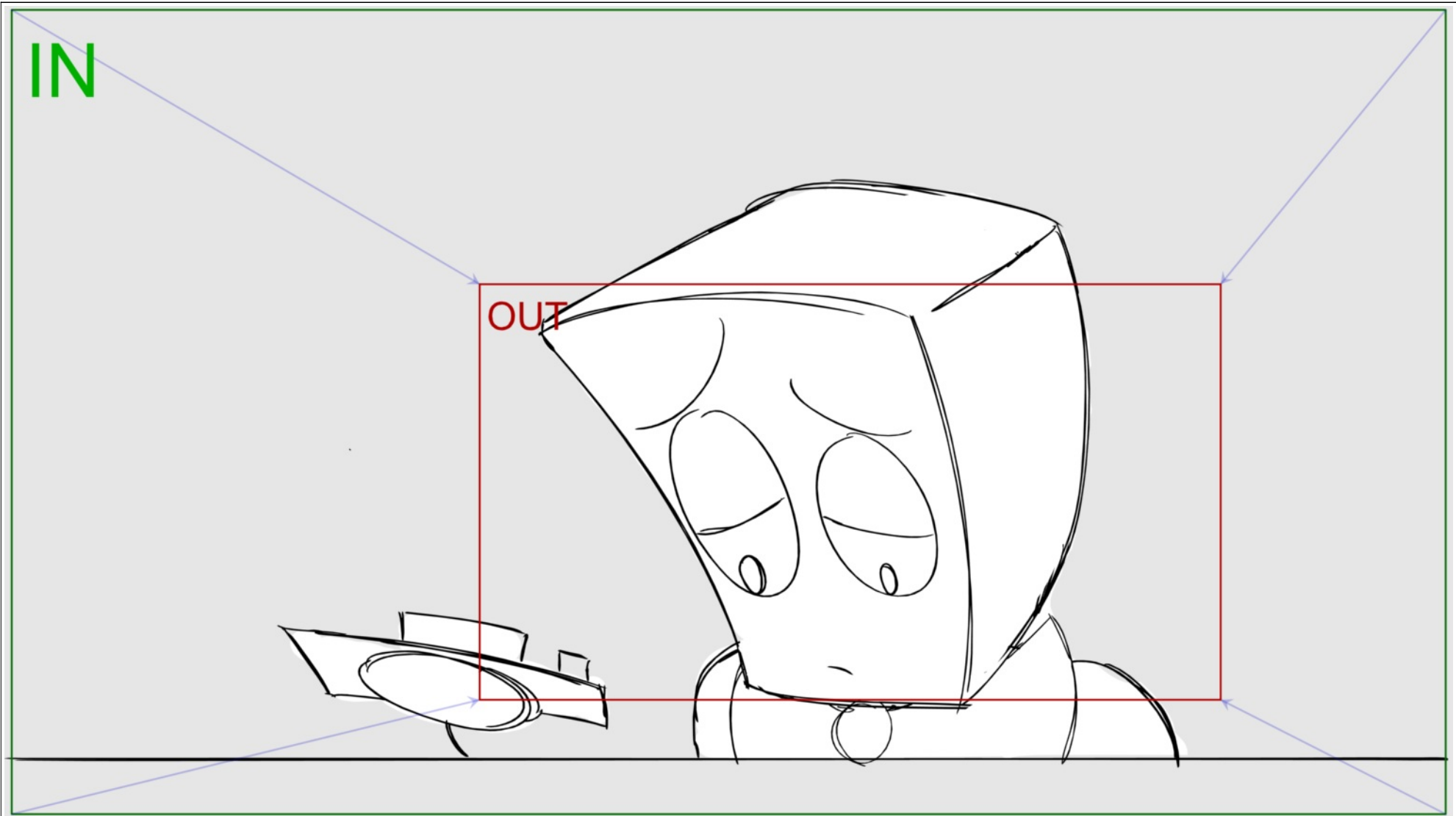

Scene	Duration	Panel	Duration
1_A_1_A_1	10:06	1	01:18

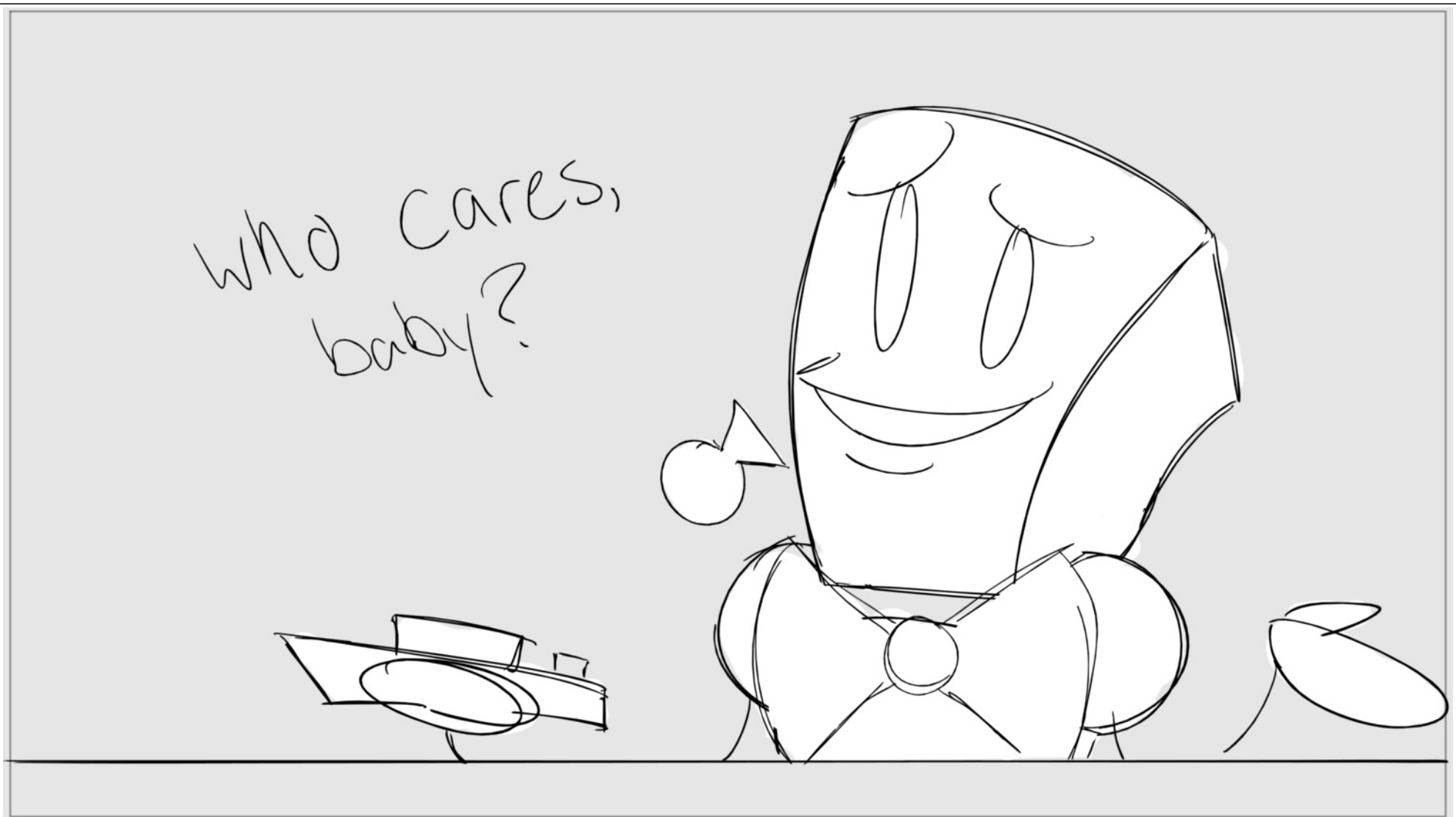

Scene	Duration	Panel	Duration
1_A_1_A_1	10:06	2	01:00



Scene	Duration	Panel	Duration
1_A_1_A_1	10:06	3	01:12



Scene	Duration	Panel	Duration
1_A_1_A_1	10:06	4	01:00



Scene	Duration	Panel	Duration
1_A_1_A_1	10:06	5	01:00



Scene	Duration	Panel	Duration
1_A_1_A_1	10:06	6	01:00



Scene	Duration	Panel	Duration
1_A_1_A_1	10:06	7	03:00

